



IAEA

International Atomic Energy Agency

Summary for FT, IT and SE

Yuanxi Wan

**20th IAEA Fusion Energy Conference
1 - 6 November 2004 Vilamoura, Portugal**



Introduction

- After the 15th IAEA Conference, 1994, the name of International Conference on Plasma Physics and controlled Nuclear Fusion Research has been changed to be IAEA **Fusion Energy Conference**,
- Which means
 - The Plasma Physics and Controlled Nuclear Fusion Research have made significant progress;
 - and therefore the **more emphasizes** on Plasma Sciences and Fusion Technology research can and should be moved to the ultimat goal of utilizing fusion energy for human being in near future.



Introduction

- **In this conference there is about 25% of total papers related with IT,FT, SE topics :**
- **I arrange the sequence in my summary talk as following:**
 - **Safety, Environmental and Economic Aspects of Fusion Energy;**
 - **ITER Activities**
 - **Fusion Technology and Power Plant Design**
 - **Summary and Conclusion**



20th IAEA FEC

Fusion Energy

World Population Growth

World population and energy demand growing rapidly

Predictions suggest strong growth will continue

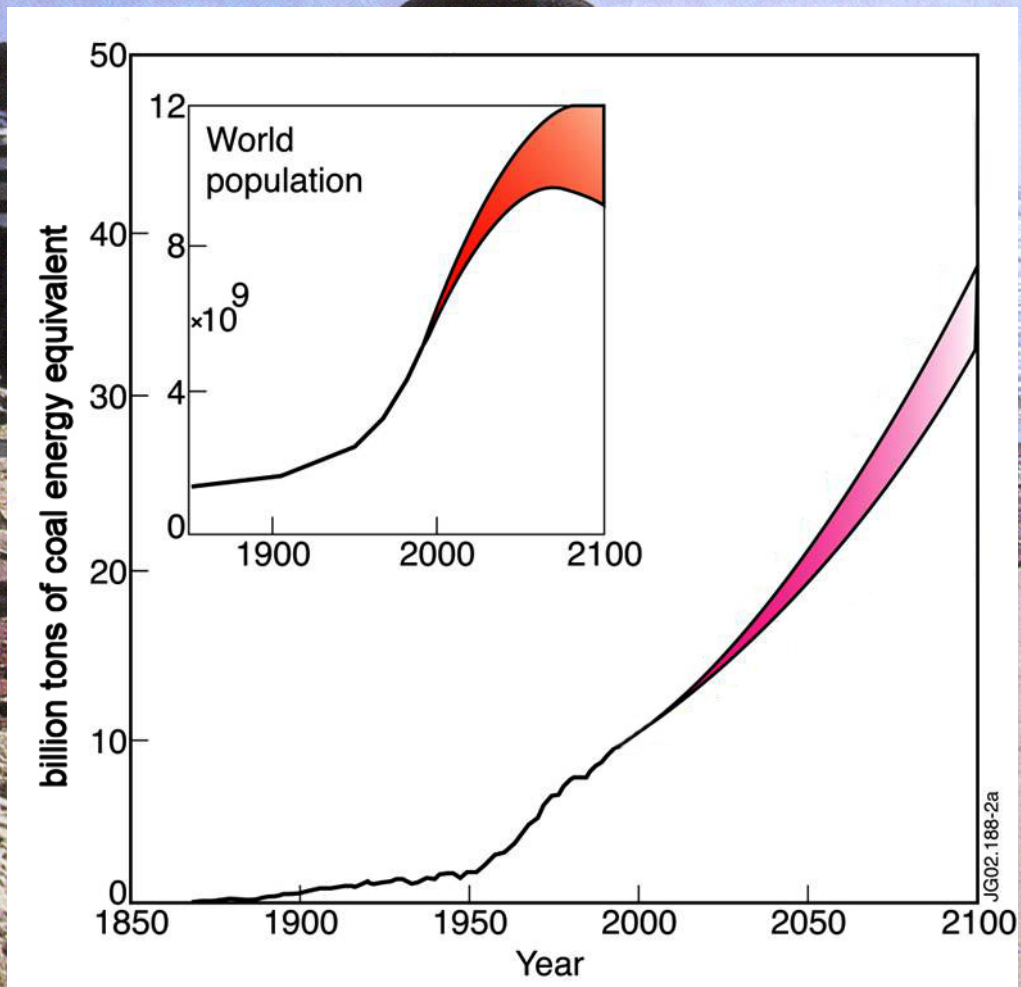



Carbon dioxide levels over the last 60,000 years

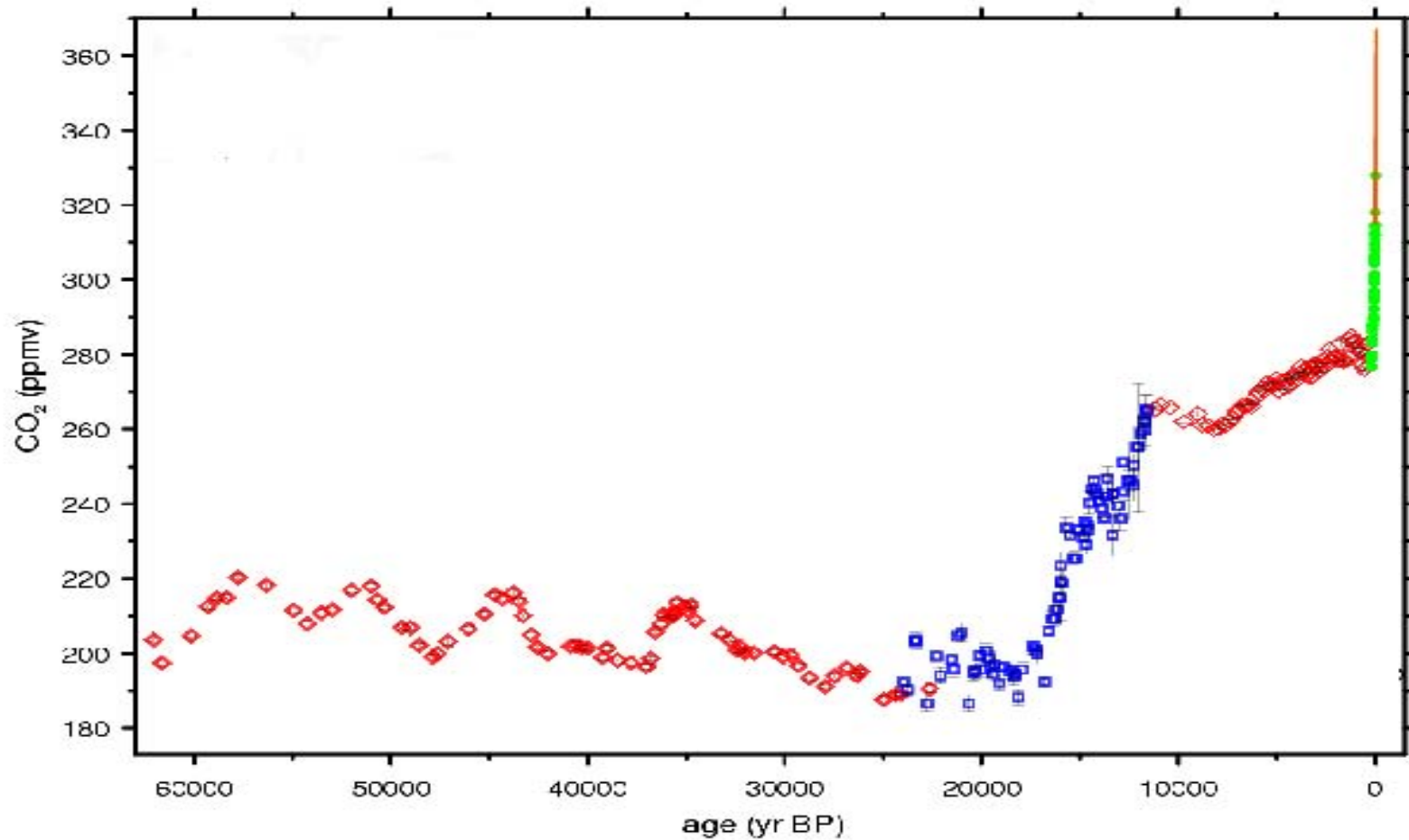



Fusion Energy

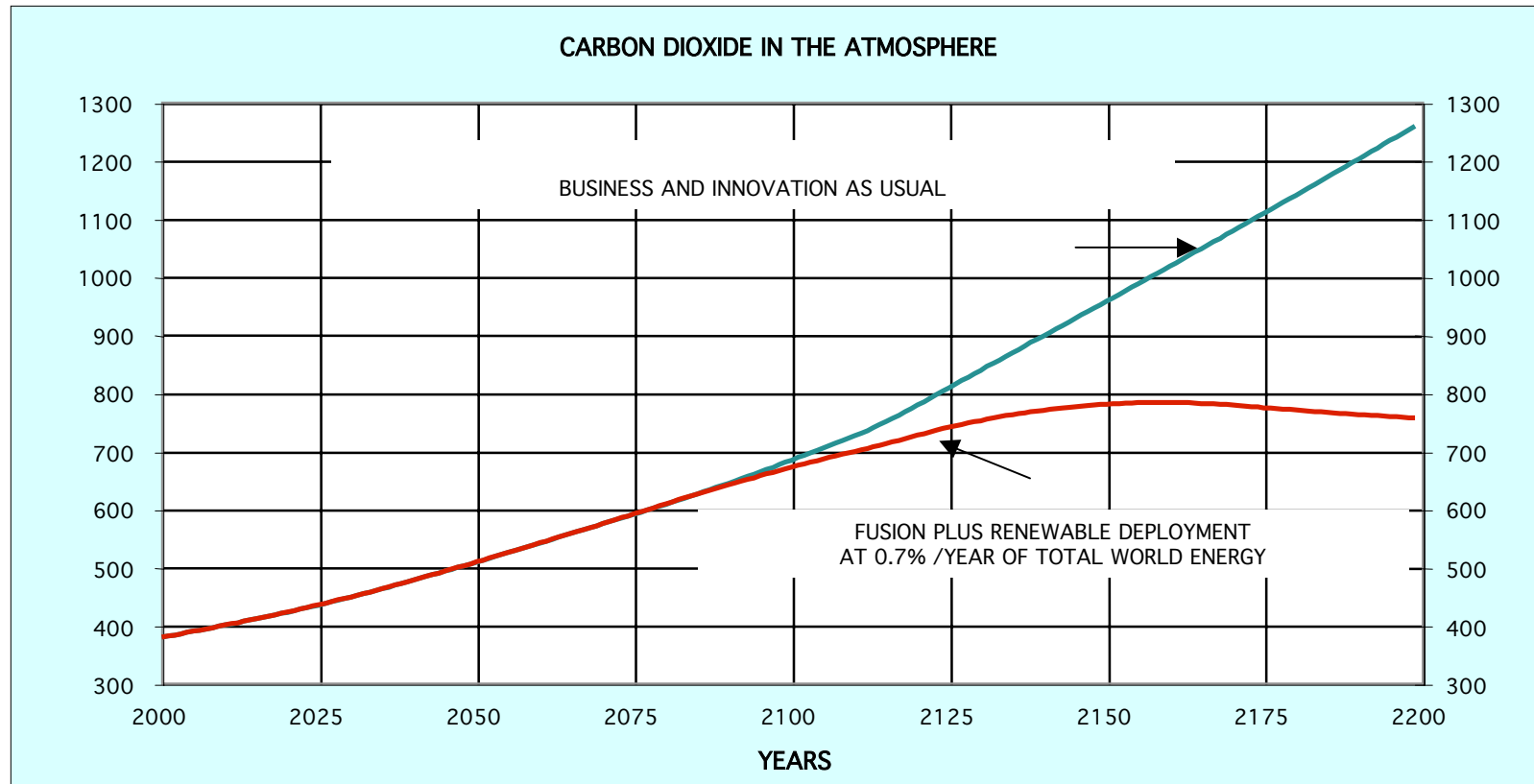

The fusion could be a major contributor to total stabilization of carbon dioxide in the atmosphere.



Fusion Energy

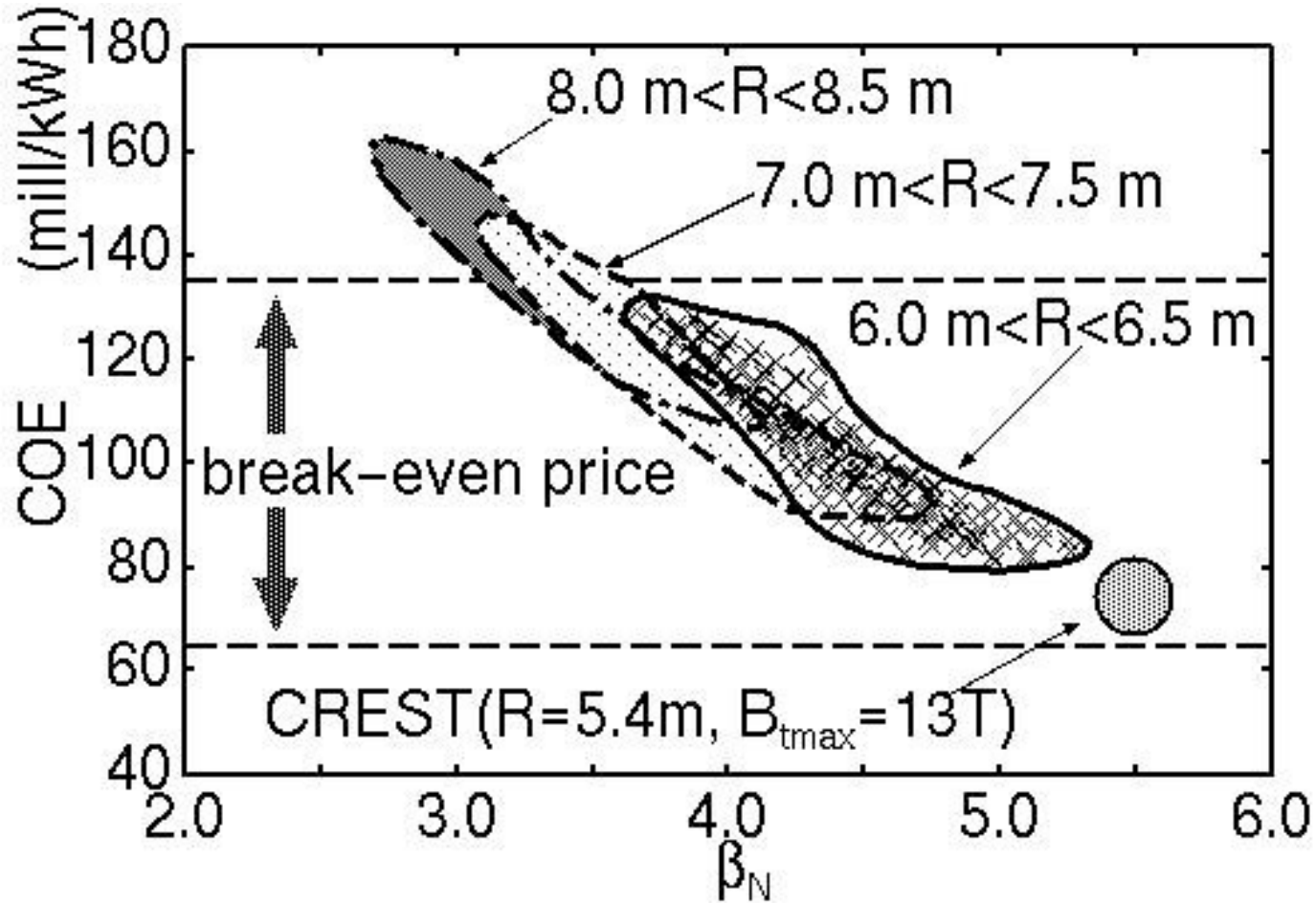

The COE will decrease with increasing of the β_N



Fusion Energy

- fusion has well-attested, attractive safety and environmental advantages,
- The cost of fusion electricity is likely to be comparable with that from other environmentally responsible sources of electricity generation;
- Through ITER the economically acceptable first generation fusion power plants could be accessed
- Fusion would capture twenty percent of the electricity market by the end of this century, or earlier *if a “fast track” development were adopted;*
- There is no risk for fusion development in spite of the fact that commercial realization is not certain.



20th IAEA FEC

ITER Activities



ITER Activities

Following 28 papers contributed by ITER team

● Physic basis

IT-1/1; IT-1/2; IT-P-3/26; IT-P-3/27;
IT-P-3/28; IT-P-3/29;
IT-P-3/30; IT-P-3/31; IT-P-3/32;
IT-P-3/33; IT-P-3/34; IT-P-3/35;
IT-P-3/36; IT-P-3/37; IT-P-4/18

● Engineering Design and R& D

- Superconducting Magnet: IT-1/4
- VV&In-VVC: IT-1/5
- Diverter Design: IT-P-3/24;
IT-P-3/26;
- Fueling and Pumping:
IT-P-3/17;

● Diagnostics and Plasma Control :

IT-P-3/19; IT-P-3/23; IT-P-3/42;
IT-P-3/22;

● Materials and Testing Facilities:

- First wall: IT-P-3/16; IT-P-3/18;
IT-P-3/21;
- Blanket : IT-P-3/20;

● Licensing: IT-1/3

The most papers are related with physic basis of ITER.....;



ITER Activities

Some changes on IT activities:

Mission of ITER (1998)

- demonstrating controlled ignition and extended burn of D-T plasma, with stead state as ultimate goal
 - demonstrating technologies essential to an reactor in an integrated system;
 - performing integrated, testing of high-heat flux and nuclear component, required to utilize fusion energy for practical purposes
- Overall, it's goal is long-pulse controlled ignition

Physic basis of ITER (1998)

- The projections for plasma performance in the ITER ELMY H-mode reference scenario can be considered to be founded on the most systematic analysis of evidence, available from existing experiments and these projections give confidence that ITER will meet it's goal of long pulse ignited operation



ITER Activities

Some changes on IT activities: (Cont.1)

Mission of ITER-FEAT(2002)

- demonstrating moderate power amplification and extended burn of deuterium-tritium plasma with steady –state as an ultimate goal
- demonstrating technologies essential to an reactor in an integrated system;
- performing integrated, testing of high-heat flux and nuclear component, required to utilize fusion energy for practical purposes

Physic basis of ITER-FEAT(2002)

- The nominal inductive operation of ITER is the H-mode confinement regime in the presence of edge localized modes (ELMy H-mode)
- Both high triangularity and high-field side pellet injection will help ITER operation with high density ($n_e \sim n_{Greenwald}$) and good confinement quality (so $Q \geq 10$ can be extrapolated)



ITER Activities

Some changes on IT activities: (Cont.2)

Main parameters of ITER (1998)

- **Total fusion power** **1.5GW**
- **Controlled ignition** **~ 1000s**
- **Neutron wall loading** **1MW/M²**
- **R₀** **8.1 m**
- **a** **2.8 m**
- **κ₉₅** **1.6**
- **δ₉₅** **0.24**
- **I_p** **21MA**
- **B_T (8.1m)** **5.7 T**
- **Divertor Configuration** **Single Null**
- **Auxiliary Heating Power** **100MW**

Main parameters of ITER (2002)

- **Total fusion power** **500(700)MW**
- **Inductive burn time (Q ≥10)** **≥400 s**
- **Neutron wall loading** **0.57(0.8)MW/m²**
- **R₀** **6.2 m**
- **a** **2.0 m**
- **κ₉₅** **1.70/ 1.85**
- **δ₉₅** **0.33/0.49**
- **I_p** **15 (17)MA**
- **B_T (6.2 m)** **5.3 T**
- **Divertor Configuration** **Single Null**
- **Auxiliary Heating / CD Power** **73MW**



ITER Activities

The following issues will most directly determine plasma performance of ITER

- Energy confinement, edge parameters and capacity to *reach* and *sustain* H mode;
- *β value* and particle *density*;
- Impurity dilution, radiation losses, helium exhaust and divertor power handling.
- *Stead state operation*

All of them form the most important physic basis of ITER



IT- Physic Basis

Summarize recent progress in the physics basis and its impact on the expected performance of ITER:

- **H-mode confinement can be obtained at densities close to, or exceeding, the Greenwald density by increasing the triangularity and by using pellet injection or impurity gas puffing.**
- **A number of plasma parameters can be achieved in AT regimes (not simultaneously) are similar to, or above, the minimum values required for ITER steady-state $Q > 5$ operation by stabilization of Resistive Wall Mode by feedback control, assisted by plasma rotation with reduced error fields**
- **Tailoring the current profile can improve confinement over the standard ELMy H-mode and allow an increase in beta up to the no-wall limit at safety factors ~ 4 . Consequently, the hybrid operation could provide an attractive scheme for high $Q (>10)$, long pulse (> 1000 s) operation with benign ELMs**
- **Neoclassical Tearing Mode (NTM) suppression by localized EC current drive has been successfully demonstrated in experiments and can be projected to ITER.**
- **Analysis of disruption scenarios has confirmed the robustness of the ITER design against disruption forces with plasma currents up to 15 MA. Disruption prediction and mitigation techniques have been proposed.**



IT- Design and R&D

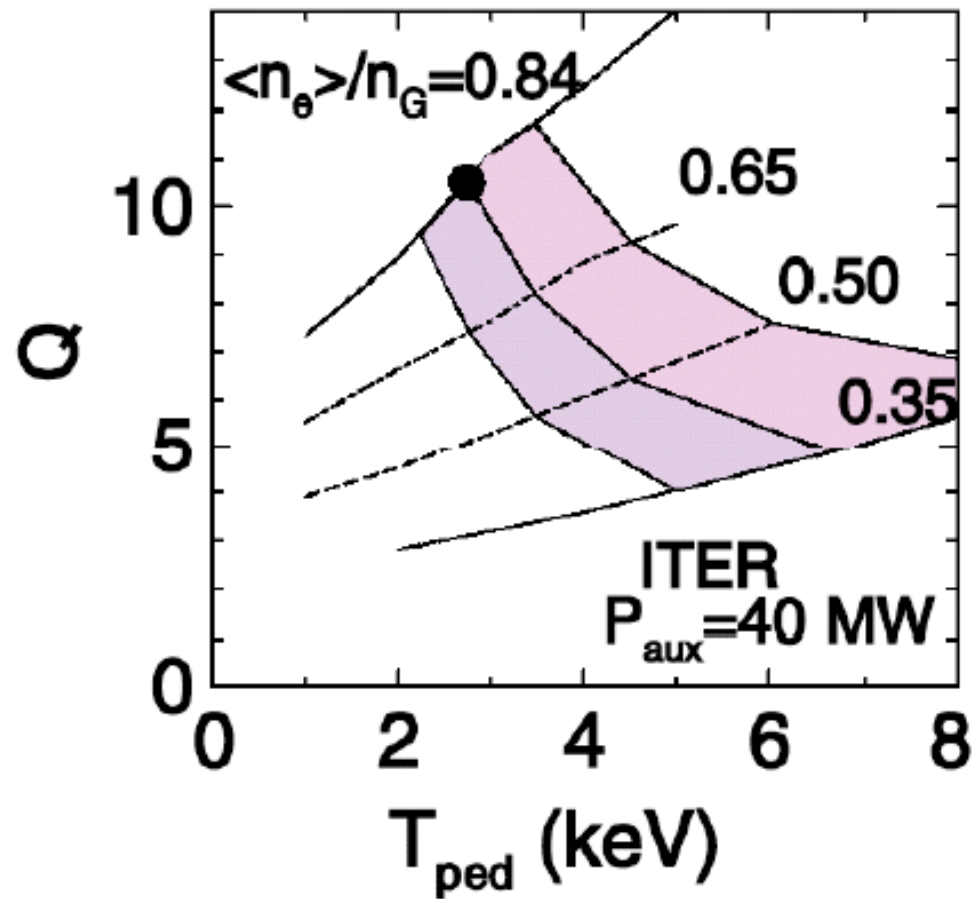

$Z_{eff} \sim 1.3$ is assumed



Edge Localised Modes (ELM)

The amplitude of ELMs can be reduced by inducing frequent ELMs by pellet injection (ASDEX Upgrade) or by edge ergodisation (DIII-D)

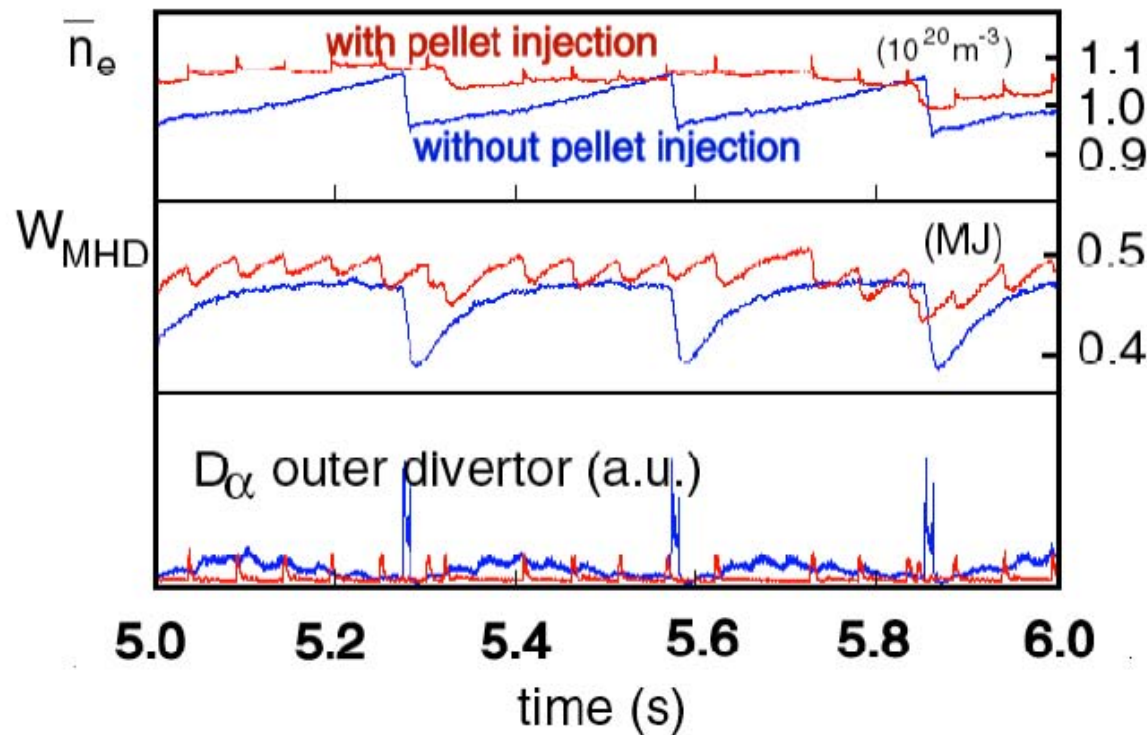

With pellet injection, a small confinement deterioration ($\sim 10\%$) is observed.



Resistive Wall Modes (RWM)

DIII-D experiments demonstrate that RWM can be suppressed by a combination of plasma rotation and feedback control with external coils. An analysis shows that RWM control is possible up to $C_\beta \sim 0.8$ ($C_\beta = (\beta - \beta_{\text{no wall}})/(\beta_{\text{ideal wall}} - \beta_{\text{no wall}})$) in ITER. (Liu and Bondeson, TH/2-1, Gribov and Kavin, IT/P3-22)

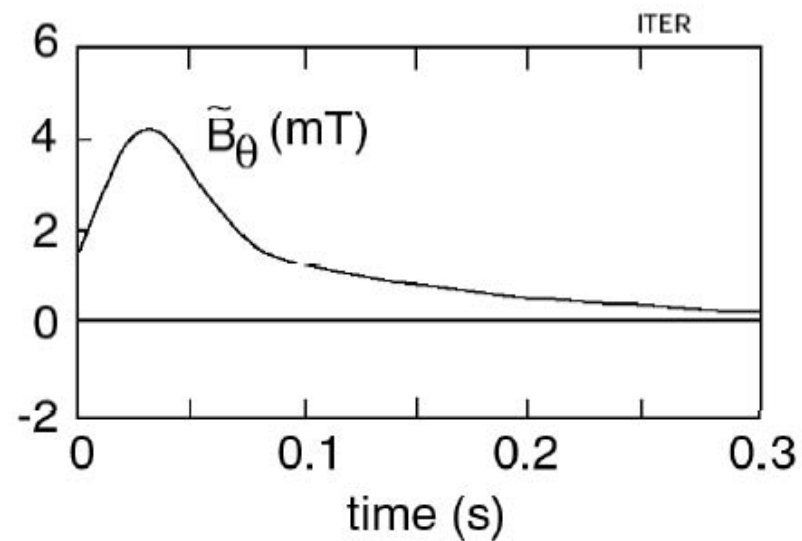
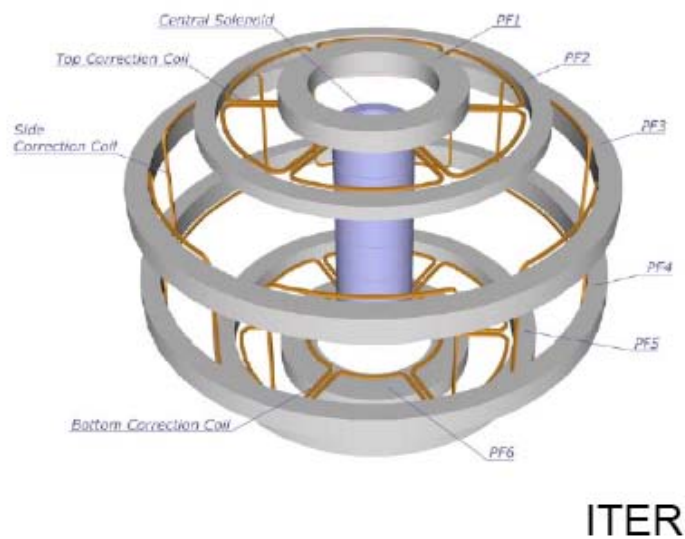



Neoclassical Tearing Modes (NTM) Suppression by ECCD

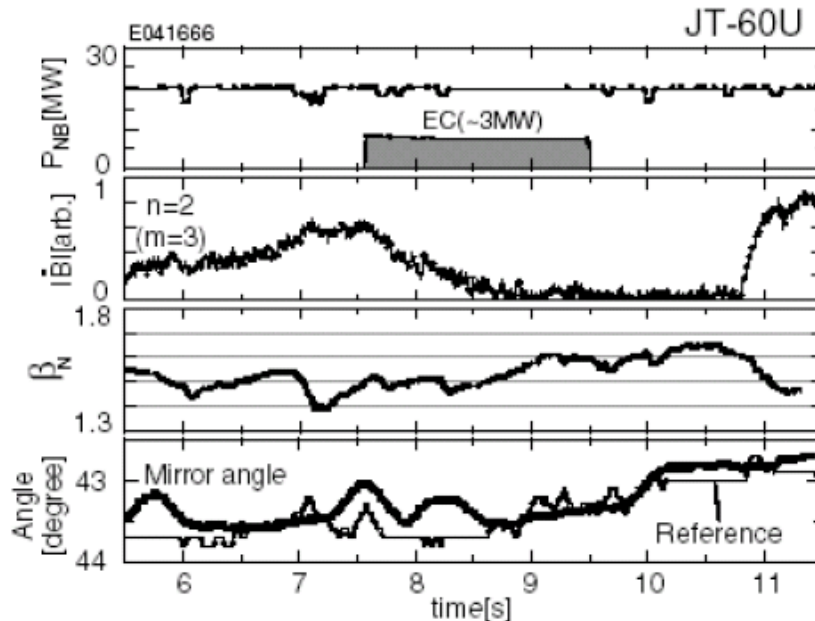

Suppression of NTM has been demonstrated for 2/1 and 3/2 modes (ASDEX Upgrade, DIII-D, JT-60U). The magnetic island is tracked real-time and early injection has reduced the required power (JT-60U).

The required power in ITER is estimated to be 10-30 MW

Good confinement is observed in the presence of n=2 or 3 tearing modes

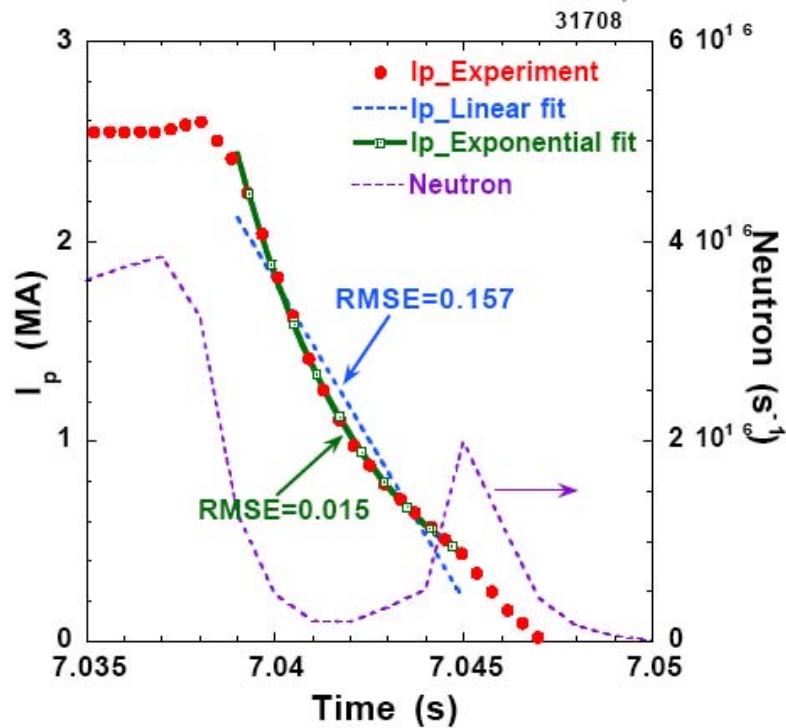

Fig. 1

Photo-neutrons are observed for the fast quench case

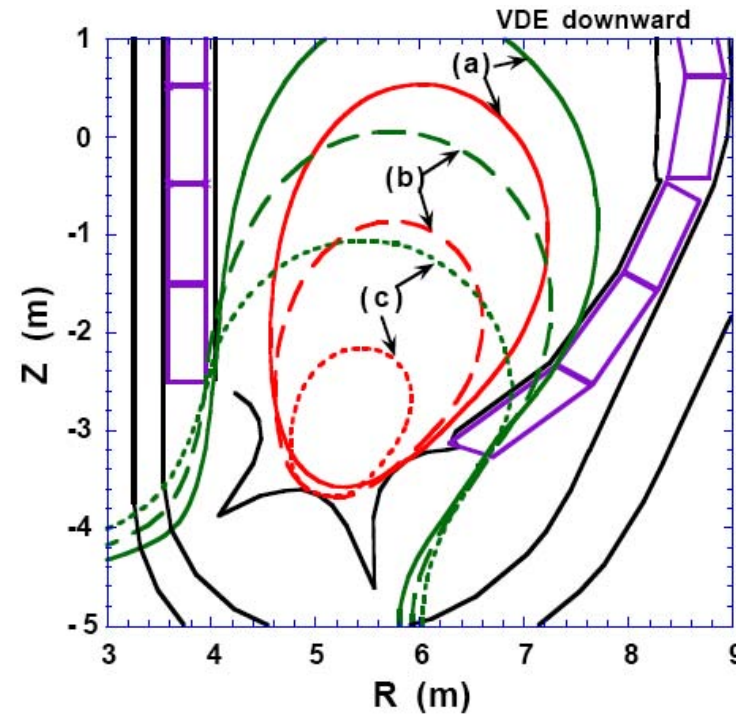

Fig. 2

Figure shows the time evolution of plasma (LCFS) and halo boundaries for a case of a downward VDE.

IT-P3/29 by M.Sugihara etc

- Disruptions and ELMs will be erosion divertor armour and contamination SOL
- Noble Gas Injection into Tokamak Plasmas can be mitigation of the deleterious effects



Engineering design and R& D

- The most R&D activities have been done successfully;
- The design of SC magnet system is improved and optimized
- The detail engineering design of VV & in-vessel components has almost completed and read for fabrication
- More widely investigation for the design of diverter and blanket are still needed

ITER is ready to transfer to construction phase



IT- Design and R&D

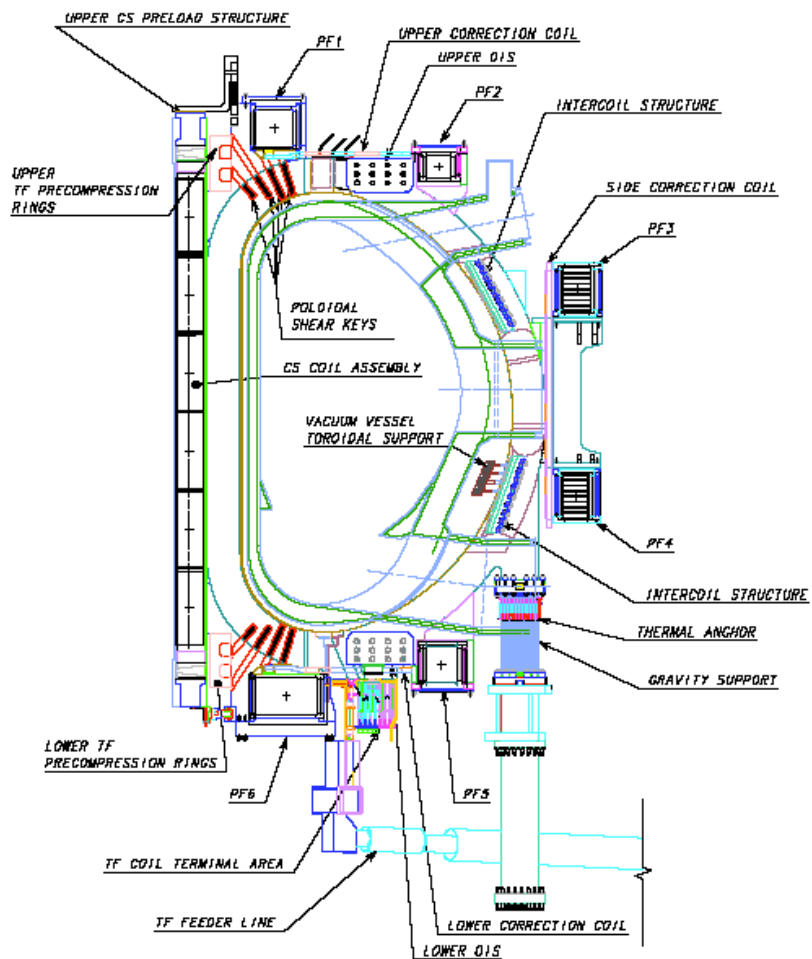

Cross-section of ITER magnets

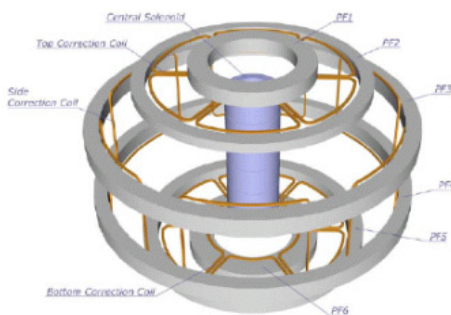

Saddle coils

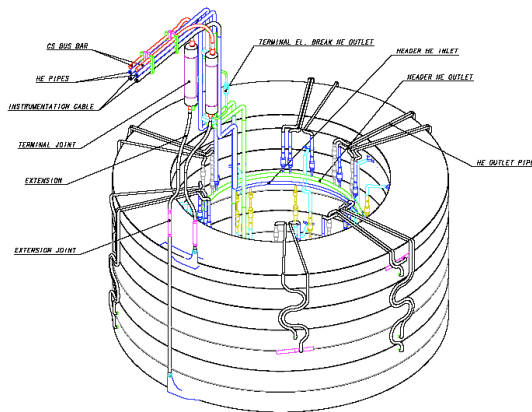

Central Solenoid

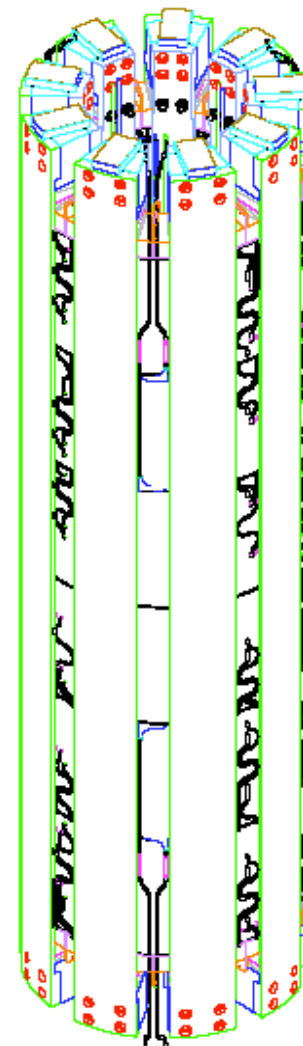

Design of the ITER Magnets to Provide Plasma Operational Flexibility



IT- Design and R&D

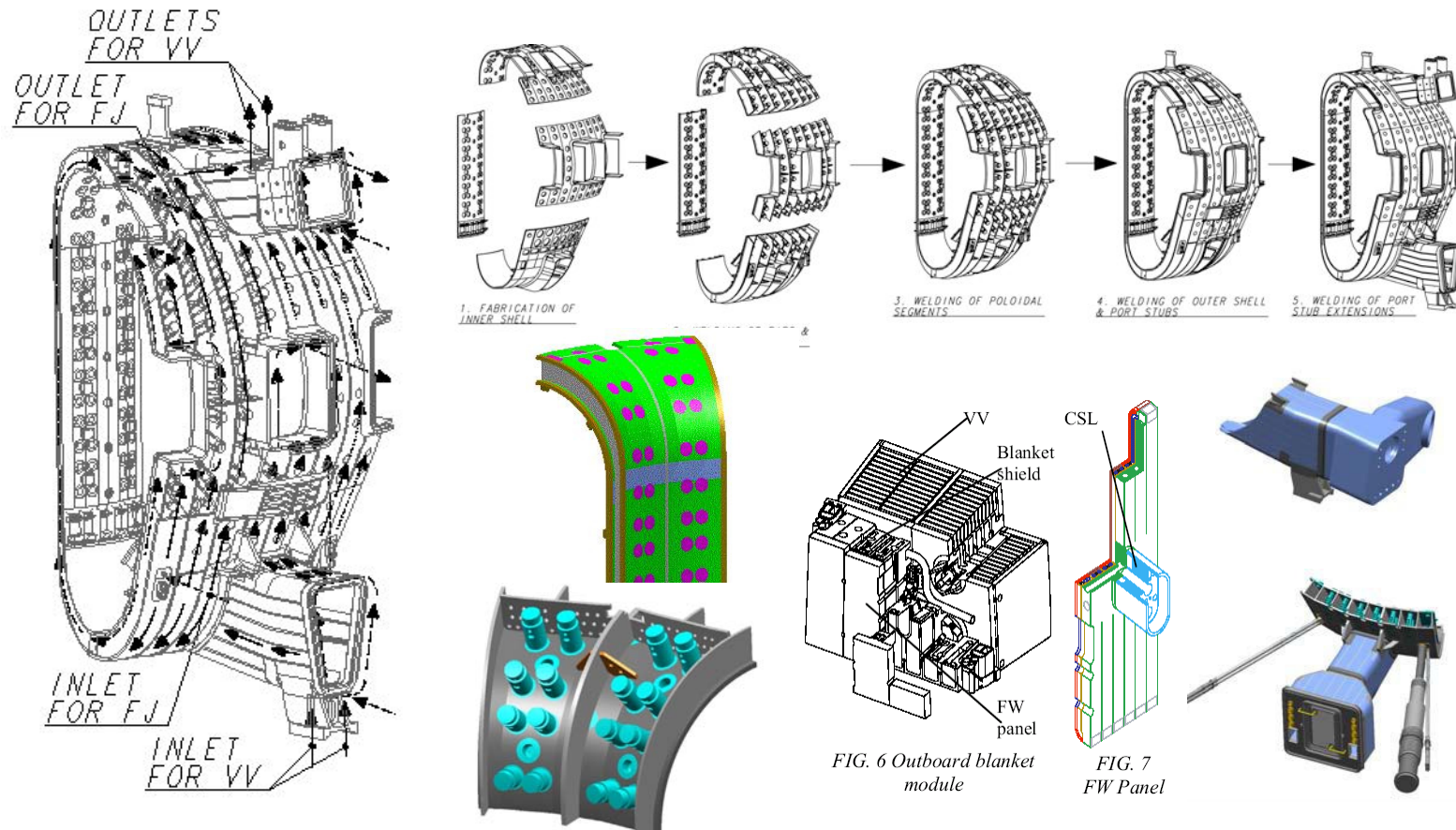

The most of the ITER VV and in-vessel component designs are converged. Additional R&D on full-scale VV partial models are now on-going and to be completed before the start of the ITER construction.

FIG. ITER 2004 Vacuum Vessel



IT- Design and R&D

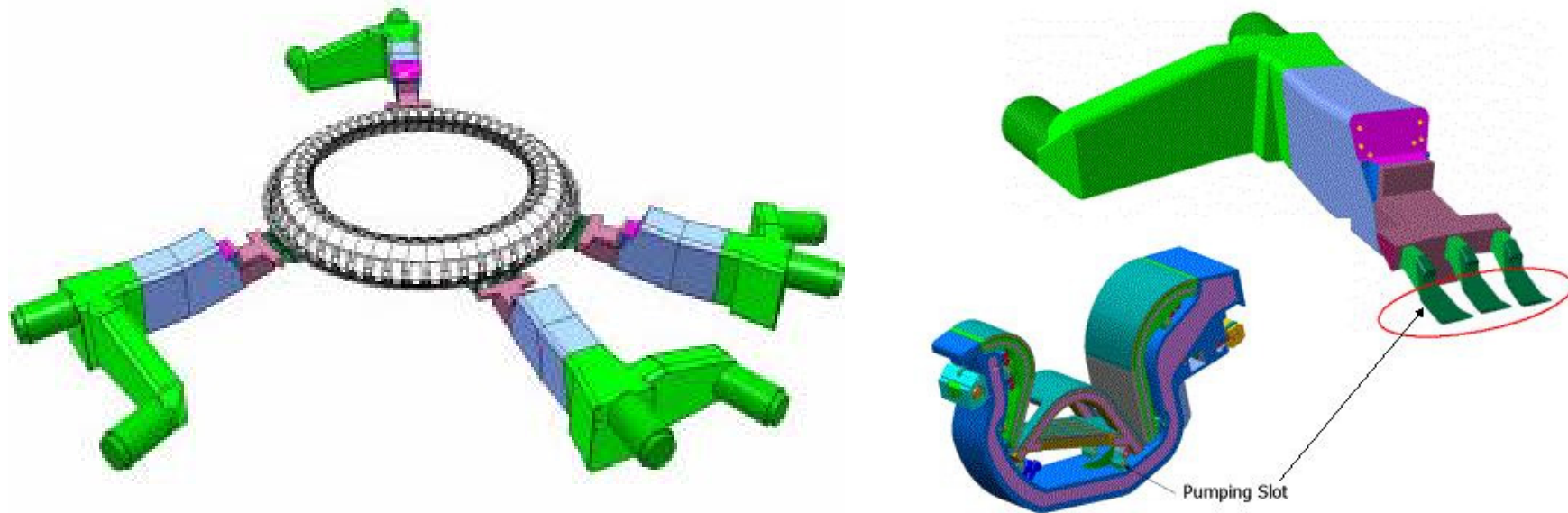

FIG. 1. Left: 3D view of the ITER exhaust gas pumping port geometry showing the connection to the branched and direct cryopumps. Right: Detailed view of the individual divertor cassette and the three fingered connection to the duct, highlighting the pumping slot cross-section.

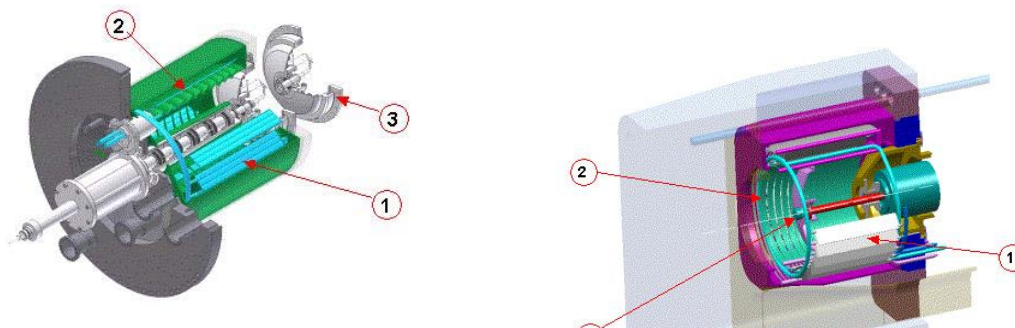

FIG. 2. Comparison of the TIMO model pump (left) and the ITER 1:1 torus exhaust cryopump (right) showing the pumping panels (1), baffles (2) and the inlet valve (3).

ITER high vacuum cryogenic pumping systems



IT- Design and R&D

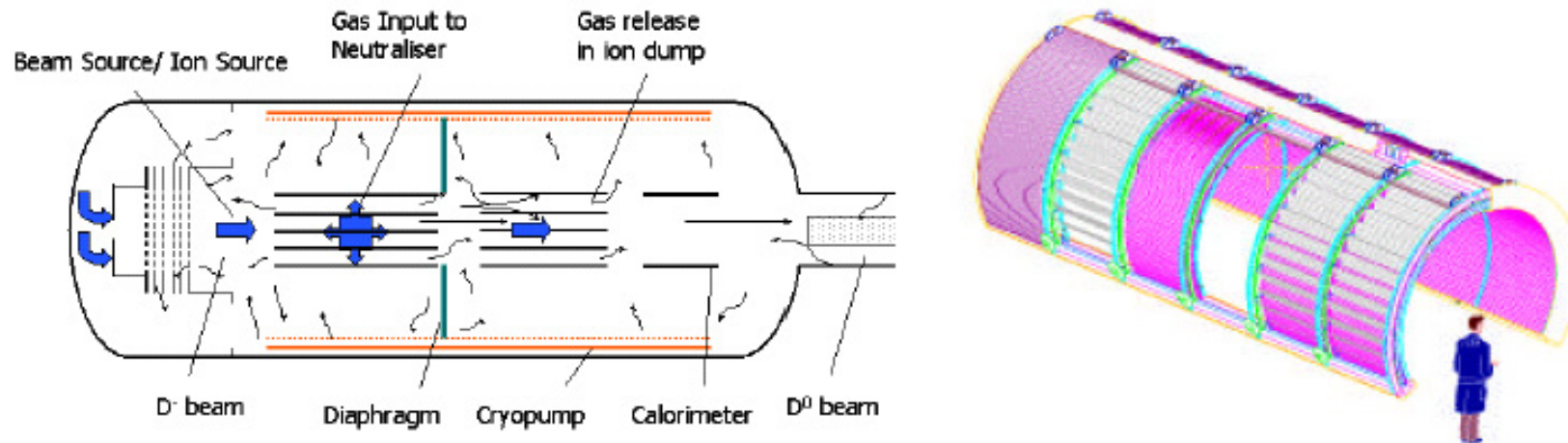

FIG. 6. Schematic set-up of the ITER NBI system, illustrating the various gas sources. The NBI cryopump system, shown to the right, is split in six modules.

Forschungszentrum Karlsruhe is developing the ITER high vacuum cryogenic pumping systems (torus, cryostat, NBI) as well as the corresponding mechanical roughing pump trains. All force-cooled big cryopumps incorporate similar design of charcoal coated cryopanel cooled to 5 K with supercritical helium. A model of the torus exhaust cryopump was comprehensively characterised in the TIMO testbed at Forschungszentrum.

ITER high vacuum cryogenic pumping systems



Diagnostics and Plasma Control

Relative to existing machines, on ITER the diagnostic components

will be subject to :

- **High neutron and gamma fluxes (up to x 10)**
- **Neutron heating (essentially zero)**
- **High fluxes of energetic neutral particles from charge exchange processes (up to x5)**
- **Long pulse lengths (up to x 100)**
- **High neutron fluence ($> 10^6$!)**



Operation Phases required by ITER FEAT

- **H phase: H operation, inductive, Ohmic L & limited H mode;**
- **D phase: D operation (limited T)**
- **D/T phase: Inductive, ELMy H-mode;**
High power D/T inductive, ELMy H-mode, high β
- **Hybrid operation(D/T phase):**
Inductive/no-inductive
- *Steady state operation (D/T phase)*

**The more advanced the operating scenarios,
the more plasma parameters need to be controlled !**

SELECTED DIAGNOSTICS for ITER

Magnetic Diagnostics	Spectroscopic and NPA Systems
Vessel Magnetics	CXRS Active Spectr. (based on DNB)
In-Vessel Magnetics	H Alpha Spectroscopy
Divertor Coils	VUV Impurity Monitoring (Main Plasma)
Continuous Rogowski Coils	Visible & UV Impurity Monitoring (Div)
Diamagnetic Loop	X-Ray Crystal Spectrometers
Halo Current Sensors	Visible Continuum Array
Neutron Diagnostics	Soft X-Ray Array
Radial Neutron Camera	Neutral Particle Analysers
Vertical Neutron Camera	Laser Induced Fluorescence (N/C)
Microfission Chambers (In-Vessel) (N/C)	MSE based on heating beam
Neutron Flux Monitors (Ex-Vessel)	Microwave Diagnostics
Gamma-Ray Spectrometers	ECE Diagnostics for Main Plasma
Neutron Activation System	Reflectometers for Main Plasma
Lost Alpha Detectors (N/C)	Reflectometers for Plasma Position
Knock-on Tail Neutron Spectrom. (N/C)	Reflectometers for Divertor Plasma
Optical Systems	Fast Wave Reflectometry (N/C)
Thomson Scattering (Core)	Plasma-Facing Comps and Operational Diag
Thomson Scattering (Edge)	IR Cameras, visible/IR TV
Thomson Scattering (Divertor region)	Thermocouples
Toroidal Interferom./Polarimetric System	Pressure Gauges
Polarimetric System (Pol. Field Meas)	Residual Gas Analyzers
Collective Scattering System	IR Thermography Divertor
Bolometric System	Langmuir Probes
Bolometric Array For Main Plasma	Diagnostic Neutral Beam
Bolometric Array For Divertor	



Materials and Test Facilities:

- **Beryllium plasma impurities suppress carbon erosion
and reduce deuterium retention in codeposited material**
- **Effects of ELMS and Disruptions on ITER Divertor Armour
Material**
- **Transport and Deposition of Hydrocarbons in the Plasma
Generator PSI-2 Experiment and Modelling**

Beryllium plasma impurities suppress carbon erosion and reduce deuterium retention in codeposited material.

- Beryllium rich surface layers form on materials exposed to beryllium containing deuterium plasma in PISCES-B
- Surface layers suppress erosion of carbon substrate material
- Hydrogen isotope retention in codeposited material is also substantially reduced and is easier to remove by baking
- Be layers also form on W samples exposed to Be containing plasma and may result in Be-W alloys formation

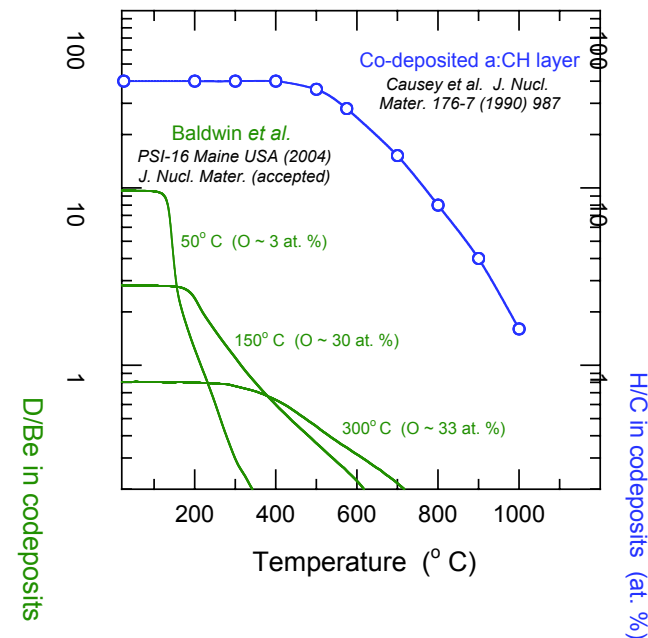
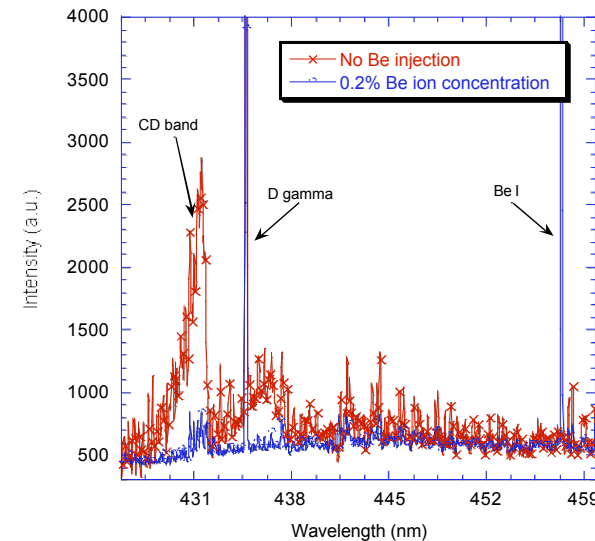



IT-Materials and Test Facility

Experiments are conducted in Russian plasma gun QSPA located in SRC RF TRINITI

QSPA facility provides adequate pulse durations and energy densities. It is applied for erosion measurement in conditions relevant to ITER ELMs and disruptions

View of QSPA facility

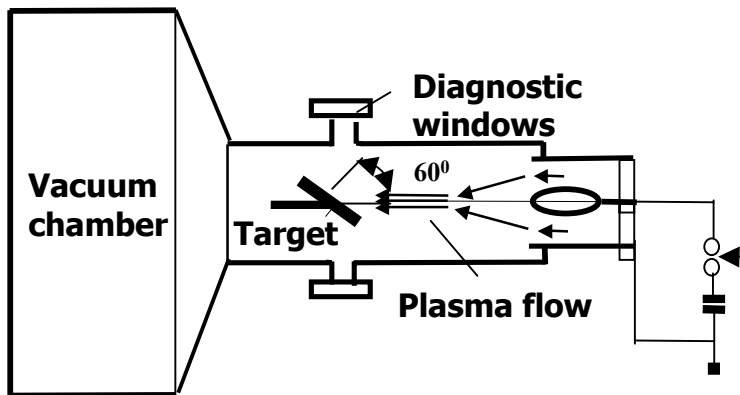

The diagram of QSPA facility



Plasma parameters (ELMs):

Heat load	0.5 – 2 MJ/m²;
Pulse duration	0.1 – 0.6 ms;
Plasma stream diameter	5 cm;
Magnetic field	0 T
Ion impact energy	≤ 0.1 keV
Electron temperature	< 10 eV
Plasma density	≤ 10²²m⁻³



IT-Materials and Test Facility

1. Change of tungsten macrobrush surface with shot number increasing at QSPA facility ($Q=1.5 \text{ MJ/m}^2$, $t=0.5 \text{ ms}$)



a) Initial surface



b) after 10 shots

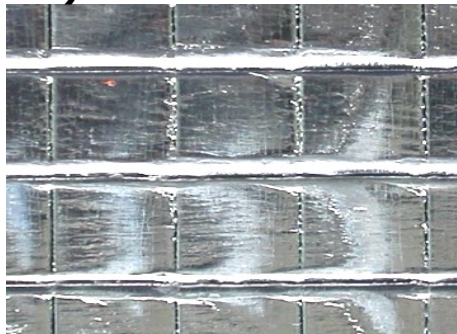

c) after 60 shots

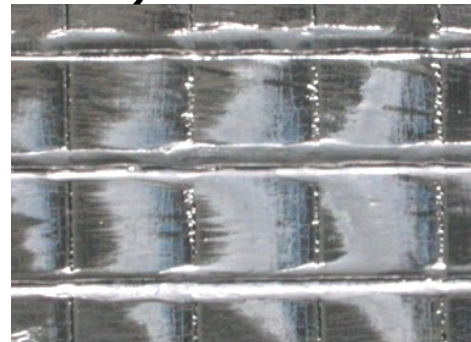

d) after 80 shots

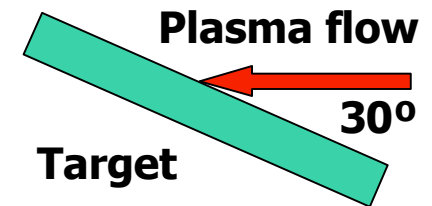

- **no catastrophic damage is observed**
- **gaps remain open (stress at interface is minimized)**
- **fine surface cracks do not propagate and re-melt in each shot**



Licensing

- The last important issue is licensing;
- **Sites in Canada, France, Japan and Spain** entered into discussions with their regulatory agencies in various stages of formality since 2001. As a result, the licensing processes were better defined, the requirements for submissions outlined, and the elements of the ITER safety approach that needed further attention were identified.
- **ITER is the first reactor-scale fusion facility to seek regulatory approval, and in fact initiated the process in four countries.**
- The ITER safety case has been developed in conjunction with an international team of safety experts for over a decade. For the past five years, discussions have taken place with the actual regulators who would have been in charge of licensing ITER for their country. **These initial steps in licensing ITER have allowed for refining the safety case and provide confidence that the design and safety approach will be licensable.**



20th IAEA FEC

Fusion Technology



Following 68 papers contributed in FT topic

● New devices and related R&D

● Under construction:

FT-3/2; FT-3/3; FT-3/4Ra;

FT-3/4Rb; FT-3/5; FT-P-7/14;

FT-P-7/15; FT-P-7/16; FT-P-7/17

● Proposed:

FT-3/1Ra; FT-3/1Rb; FT-P-1/6;

FT-P-1/30; FT-P-7/2; FT-P-7/7;

FT-P-7/8; FT-P-7/20; FT-P-7/22;

FT-P-7/23;

● Engineering Design and R& D

● Superconducting Magnet:

FT-P-1/6; FT-P-1/7; FT-P-7/16;

● Fueling and pumping

FT-P-1/26; FT-P-6/38

● Tritium: FT-P-1/19

● Heating and Current Drive:

● RF: FT-1/1Ra; FT-1/1Rb;

FT-1/1Rc; FT-1/3; FT-P-7/15;

FT-P-7/18; FT-P-7/19

● NBI:

FT-1/2Ra; FT-1/2Rb; FT-1/2Rc

● Diagnostics and Plasma Control :

FT-P-1/24; FT-P-7/9; FT-P-7/10;



Following 68 papers contributed in FT topic (cont.)

● **Materials and Testing Facilities:**

- Structural: FT-1/4; FT-P-1/21;
- First wall: FT-P-1/16; FT-P-1/18;
FT-P-1/20; FT-P-1/25;
FT-P-1/27; FT-P-1/29; FT-P-5/36;
- Diverter and Limiter:
FT-P-1/15
- Blanket: FT-P-1/8; FT-P-1/9;
FT-P-1/10; FT-P-1/11;
FT-P-1/12; FT-P-1/13;
- Facilities: FT-1/5; FT-P-7/24;
FT-P-7/12; FT-P-7/21; FT-P-1/22;
FT-P-7/3;
- Tool: FT-P-7/25;

● **Power plane and related technologies:**

● Inertia Confinement:

FT-2/1Ra; FT-2/1Rb;

FT-P-1/14; FT-P-7/5; FT-P-7/6;

● Magnetic Confinement:

FT-3/6; FT-P-1/7;;

FT-P-7/1; FT-P-7/4; FT-P-7/11;

FT-P-7/13; FT-P-7/35;



Fusion Technology

New devices which is under construction

<u>Name</u>	<u>Country&Institution</u>	<u>Status now</u>	<u>First plasma</u>	<u>reference</u>
SST-1	India IPP	Assembled	2005	FT-3/4
EAST	China ASIPP	Is assembling	2005	FT-3/3
KASTAR	Korea. Rep. KBSI	In fabrication and testing	2007	FT-3/2
Wendelstein 7-X.	Germany IPP	In fabrication and testing	2010	FT-3/5
NCSX	USA PPPL	Production will begin soon	?	FT-P7/22



Fusion Technology

OBJECTIVES:

- Study Physics of Plasma Processes in tokamak under steady-state conditions.
 - Particle Control (fuel recycling and impurities)
 - Heat removal
 - Divertor Operation (radiation, detachment, pumping etc)
 - Current maintenance
 - LHCD, Bootstrap, advanced configurations
- Learning new Technologies relevant to steady state tokamak operation:
 - Superconducting Magnets
 - Large scale Cryogenic system (He and LN₂)
 - High Power RF Systems
 - Energetic Neutral Particle Beams
 - High heat flux handling

SST-1 : A steady state superconducting tokamak

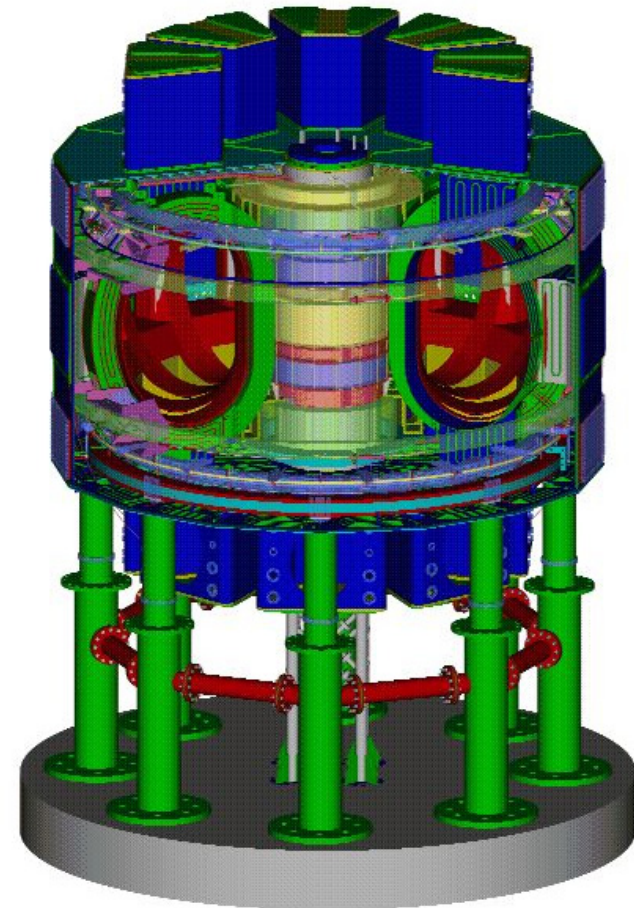



Fusion Technology

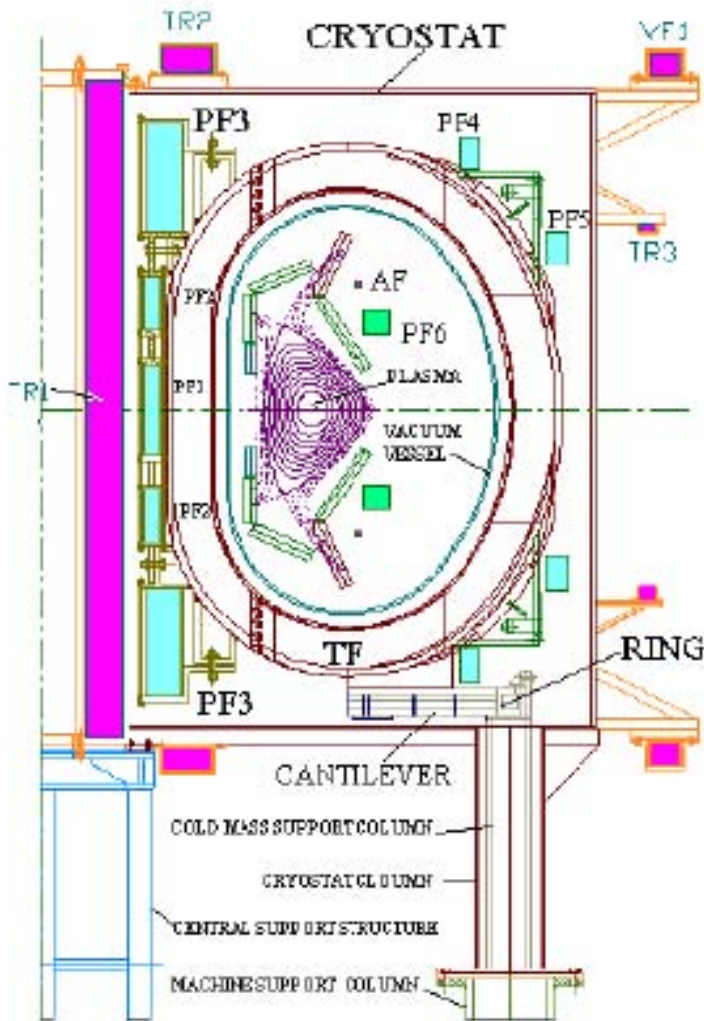

A cross-section of SST-1 Tokamak

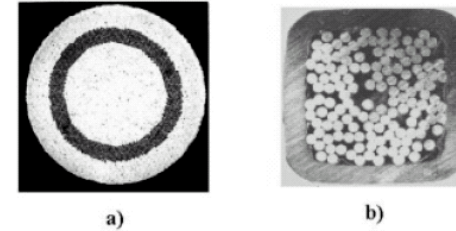

FIG. 3. Cross-section of a) the superconducting strand (0.86 mm diameter) and b) the CICC used for superconducting magnets of SST-1.



FIG. 4. TF modules on support structure

FT3-4, by Saxena etc.



Main Parameters of the EAST

	Nominal	Upgrade
B_0	3.5 T	4.0 T
I_p	1 MA	1.5 MA
R_0	1.7 m	1.7 m
a	0.4 m	0.4 m
R/a	4.25	4.25
K_x	1.2-1.5	1.5-2
$-x$	0.2-0.3	0.3-0.5
Heating and Driving:		
ICRH	3 MW	6 MW
LHCD	3.5 MW	8 MW
ECRH	0.5 MW	1.5 MW
NBI		8 MW
Pulse length	1000 s	
Configuration:	Double-null divertor Single null divertor	

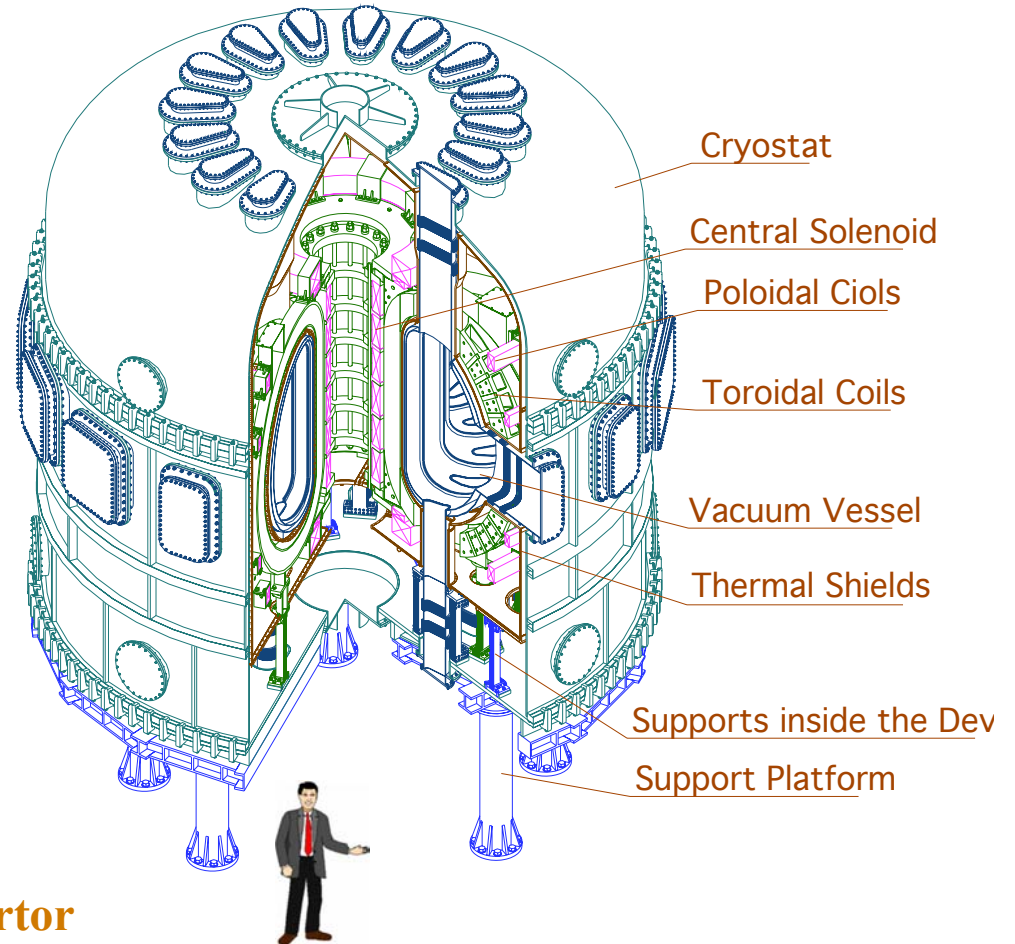



The tests of the CS prototype coil had shown pretty good results in 2003.



CS prototype coil inside the cryostat of the test facility

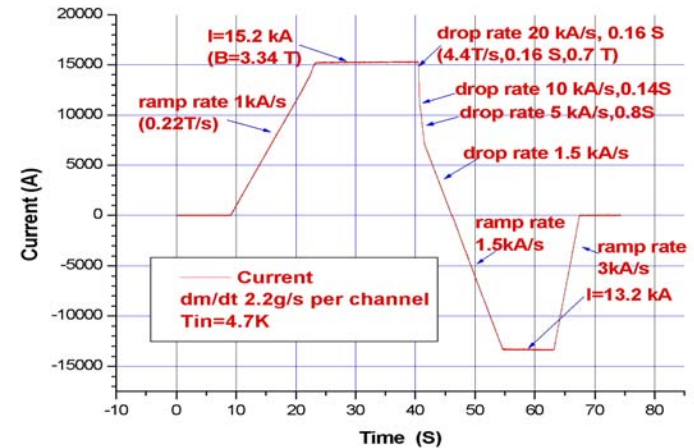

Current charge/discharge

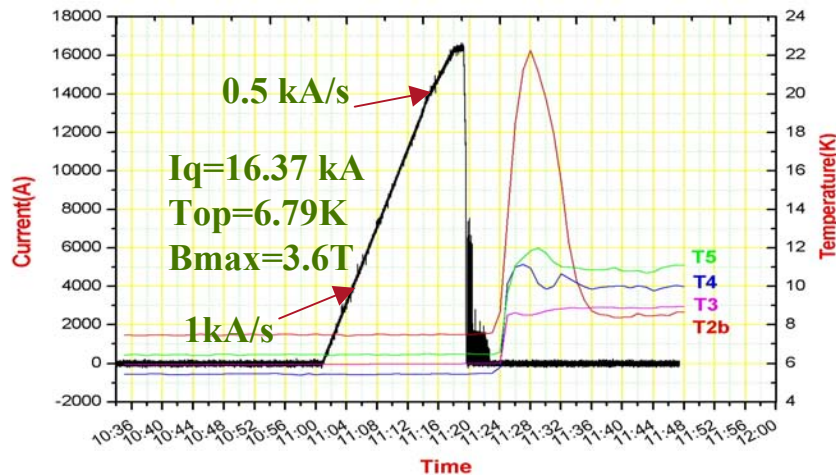

Quench current test

Extrapolated $I_q = 54\text{kA}$ (3.8K, 4.5T)

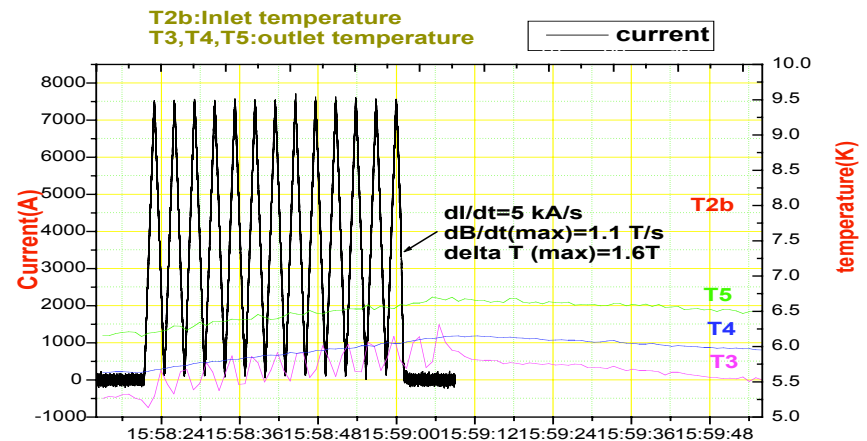

AC losses test



KSTAR Device

- Korea Superconducting Tokamak Advanced Research
- Assembly finish milestone on 2007
- Major components : Vacuum vessel, Cryostat, TF SC coils, PF SC coils, and Magnet structures

KSTAR Device & Major Components

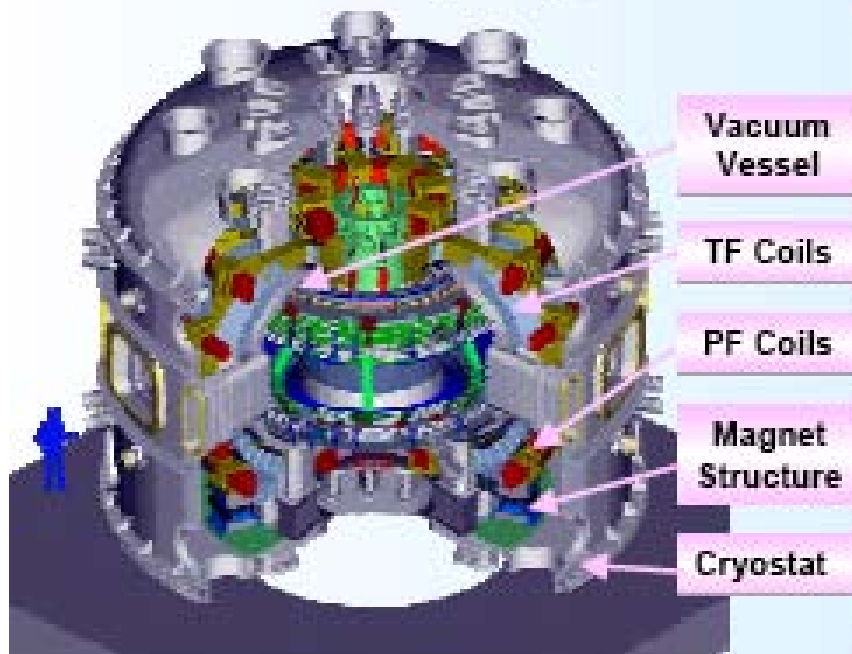

Elevation View of KSTAR

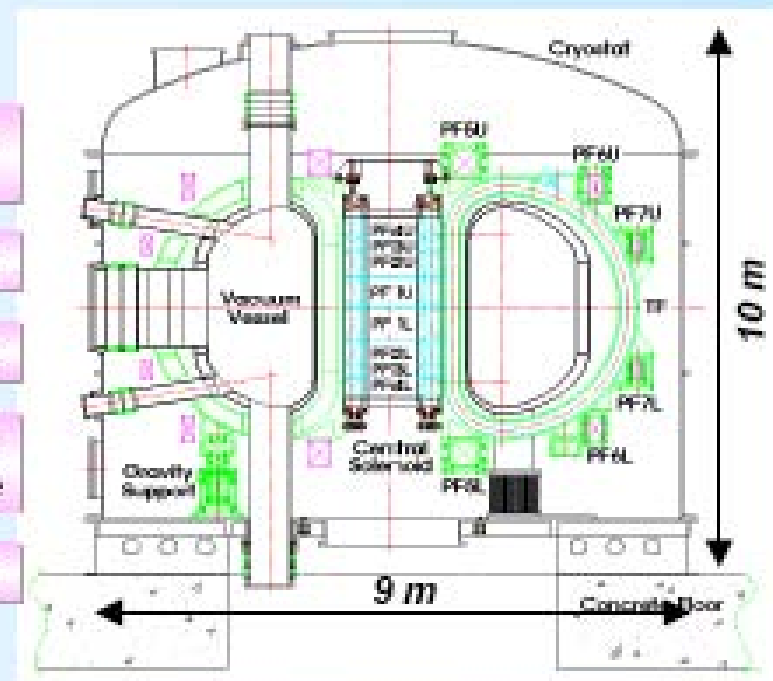



Fusion Technology

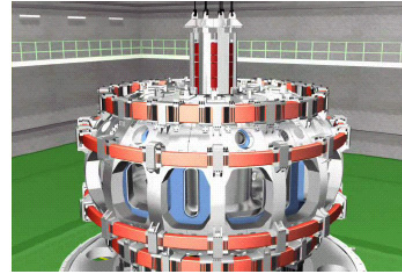
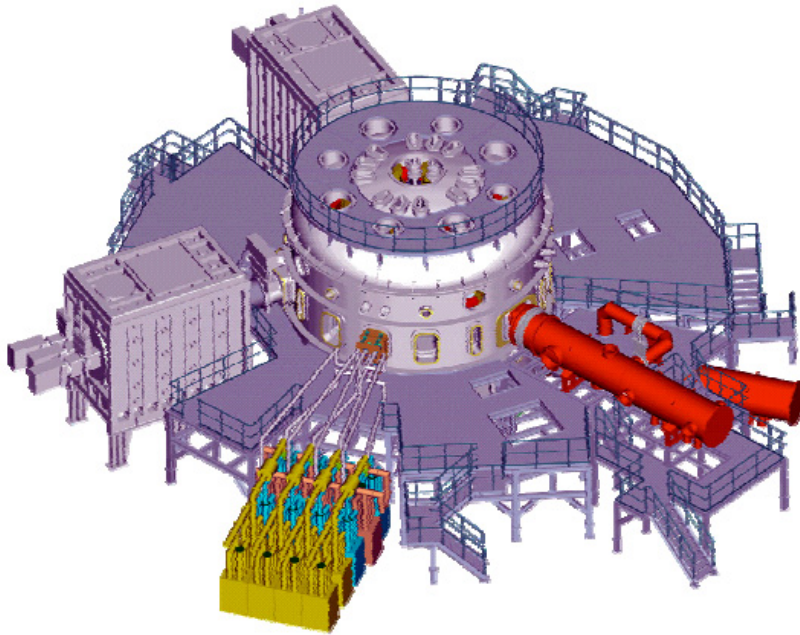

Fig. 3 Schematic drawing - assembling the central solenoid coils



Fig. 4 Schematic drawing - assembling the vacuum vessel ports

Table I. KSTAR Major Parameters

Parameters	Baseline	Upgrade
Toroidal field, B_T (T)	3.5	
Plasma current, I_p (MA)	2.0	
Major radius, R_0 (m)	1.8	
Minor radius, a (m)	0.5	
Elongation, κ_X	2.0	
Triangularity, δ_X	0.8	
Poloidal divertor nulls	2	1 & 2
Pulse length (s)	20	300
Heating power (MW)		
Neutral beam	8.0	16.0
Ion cyclotron	6.0	6.0
Lower hybrid	1.5	3.0
Electron cyclotron	0.5	1.0
Peak DD neutron source rate(s^{-1})	1.5×10^{16}	2.5×10^{16}



Fig. 12 Vacuum vessel under site welding

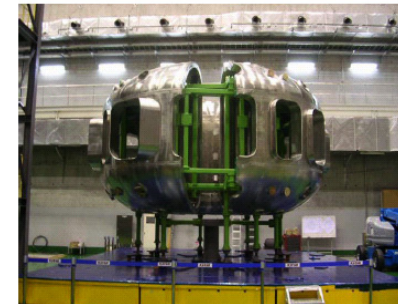

Fig. 13 Vacuum vessel after site welding

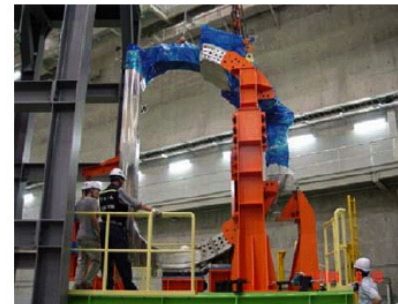

Fig. 8 Loading the TF00 magnet on the lower TF-transporter

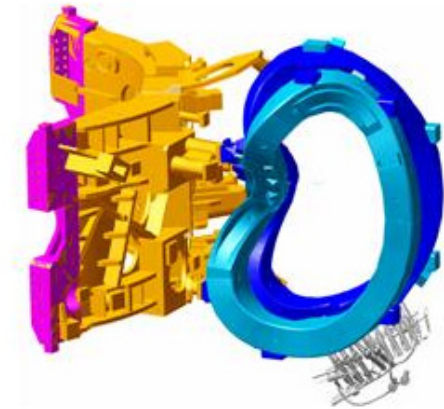
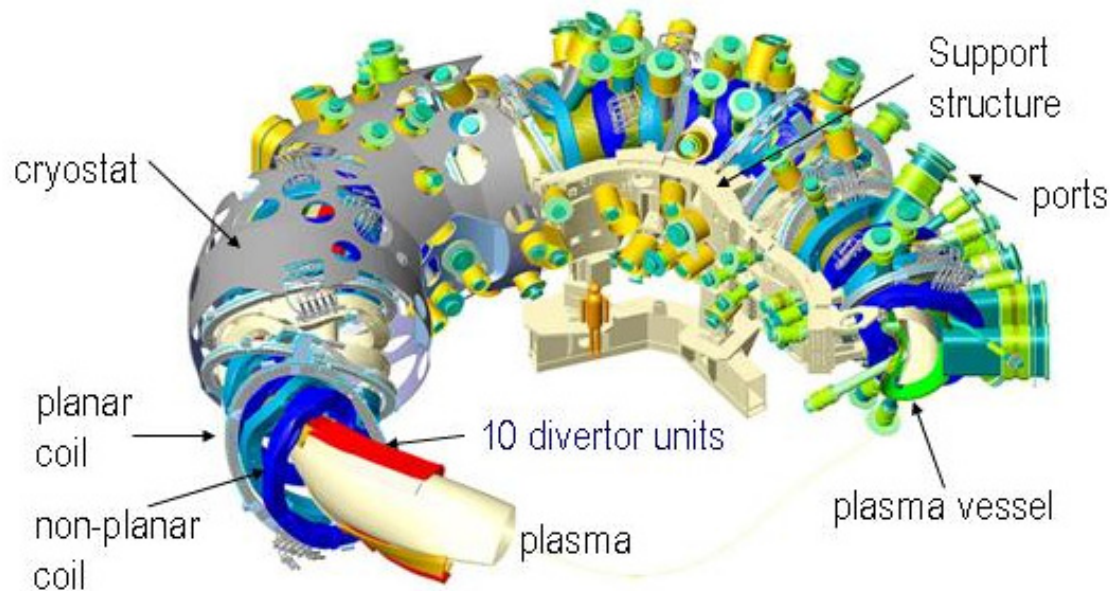

Fig. 9 The TF00 magnet after assembly test

FT3-2, by Oh, Y.K etc.



Fusion Technology



Modular coils mounted onto the coil support ring.

Components of Wendelstein 7-X.

	W7-AS	W7-X
Major radius R_0 (m)	2	5.5
Minor effective radius a_{eff} (m)	0.18	0.55
Plasma volume	1.3 m^3	30 m^3
Number of non-planar coils / conductor	45; Cu	50; NbTi
Number of planar coils / conductor	10; Cu	20; NbTi
Pulse length	10 sec	30 min
Heating power (ECRH, NBI, ICRH) (MW)	2.5, 3, 1	10, 5 (20*), 3 (9*)
Energy turn around	5. MJ	1.8 GJ

* stage II heating

**Goal: demonstration of principle reactor suitability of the optimised stellarator.
W7-X will start operation in 2010**



Fusion Technology



Fig. 5 Thermal insulation mounted onto one vessel half-module sector.

W7-X is optimised along the quasi-isodynamic principle. It is built with superconducting coils and ECRF heating and plasma exhaust are developed for 30 min operation. At present, the device is at the transition from component procurement to assembly.



Fusion Technology

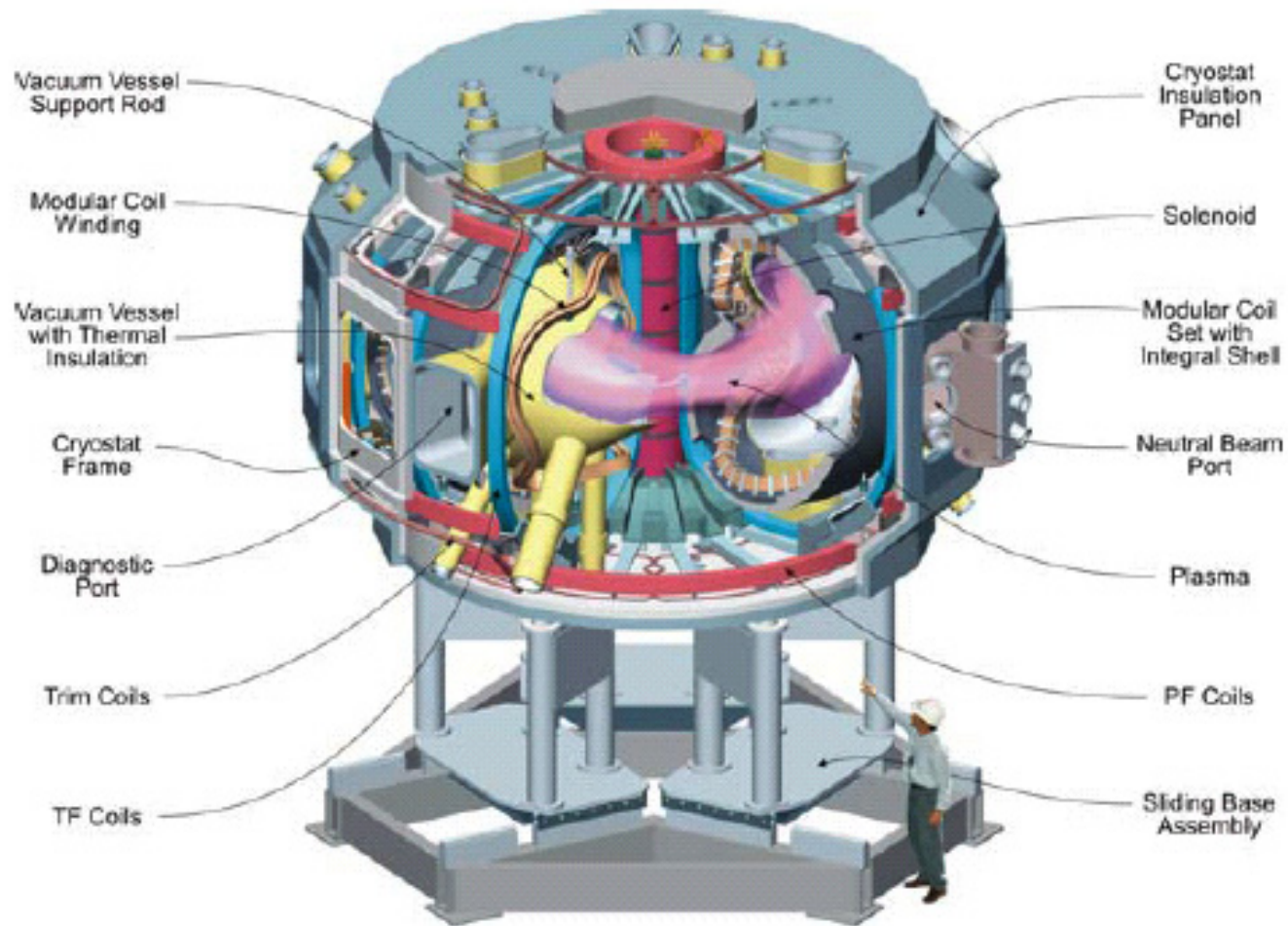

Figure 1. Details of the National Compact Stellarator Experiment



Fusion Technology

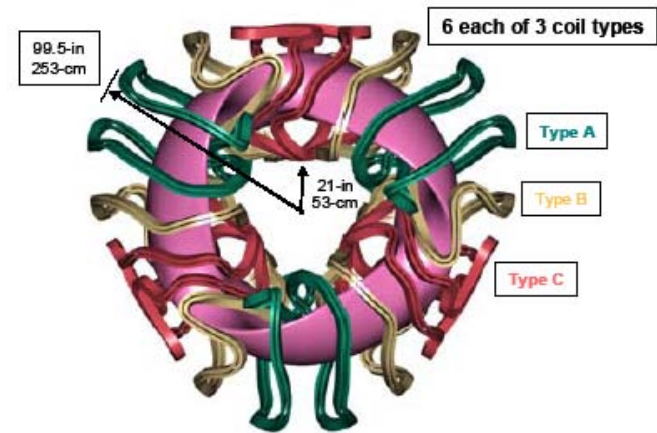
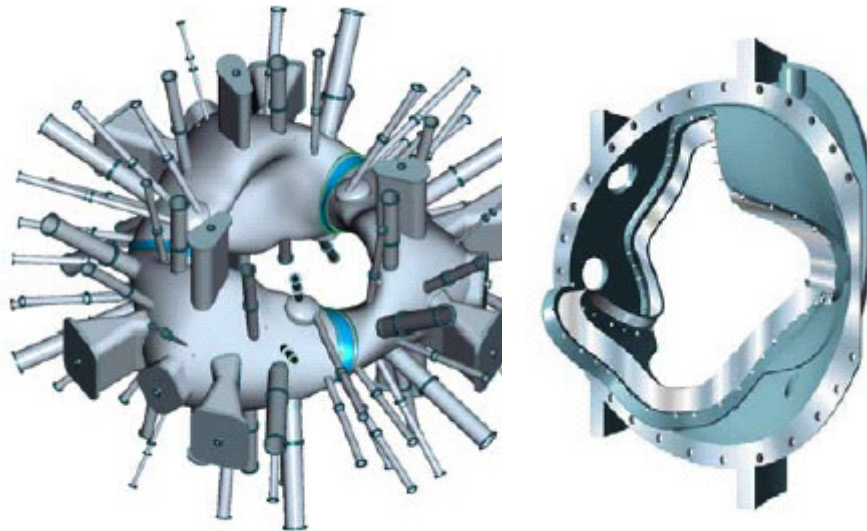

Figure 4. The NCSX plasma and modular coil system.



1. Fabrication of the NCSX Prototype Vacuum Vessel Segment

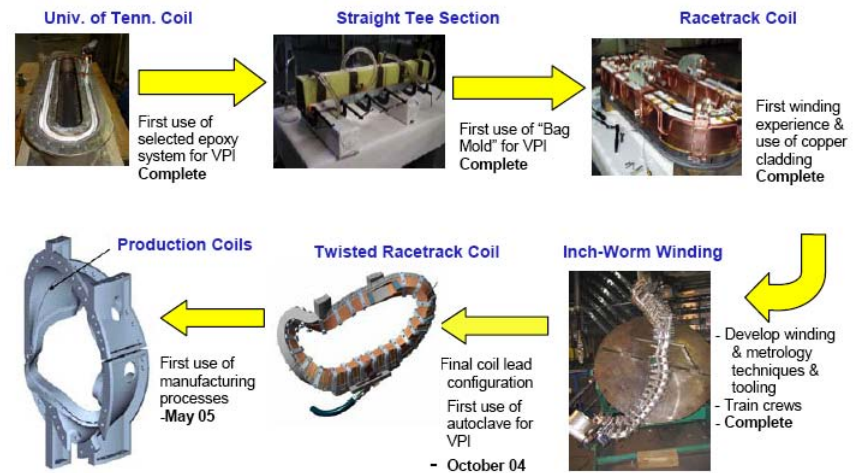

Figure 7. NCSX Modular Coil Winding Manufacturing R&D Studies



Fusion Technology

New devices which is proposed

<u>Name</u>	<u>Country</u>	<u>Institution</u>	<u>Type of device</u>	<u>Reference paper</u>
NCT(JT60-SC)	Japan	JEARI	SC Tokamak	FT-P-7/8;FT-P-1/6
CTF-US	USA	PPPL	Spherical Tokamak	FT-3-1/Rb
CTF-UK	UK	UKAEA	Spherical Tokamak	FT-3-1/Ra
FIRE	USA	PPPL	Tokamak	FT-P-7/23
IGNITOR	Italy	ENEA,Italy	High B Tokamak	FT-P-7/20

Super-Conducting JT-60 (JT-60SC) Program

- National Centralized Tokamak Device -

Important issues:

Economical & Environmental Attractiveness

- Develop high-beta and steady-state operation
- Use of low radio-activation ferritic steel

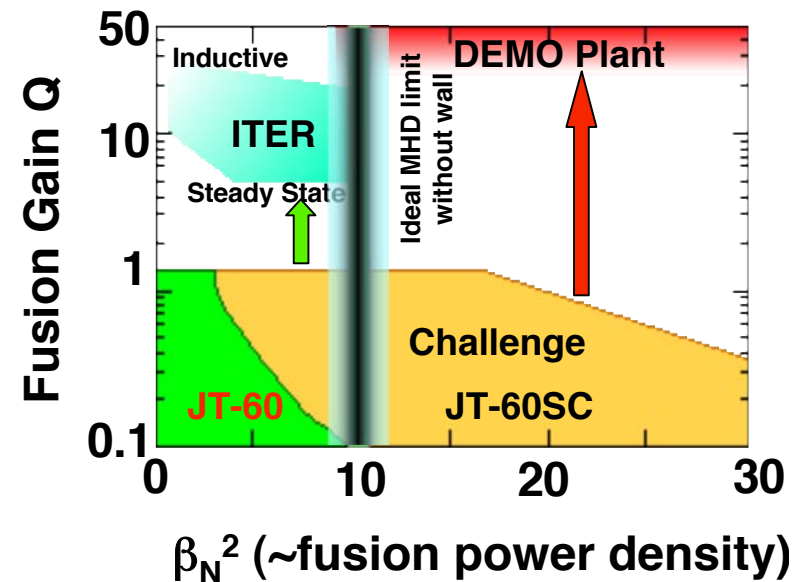
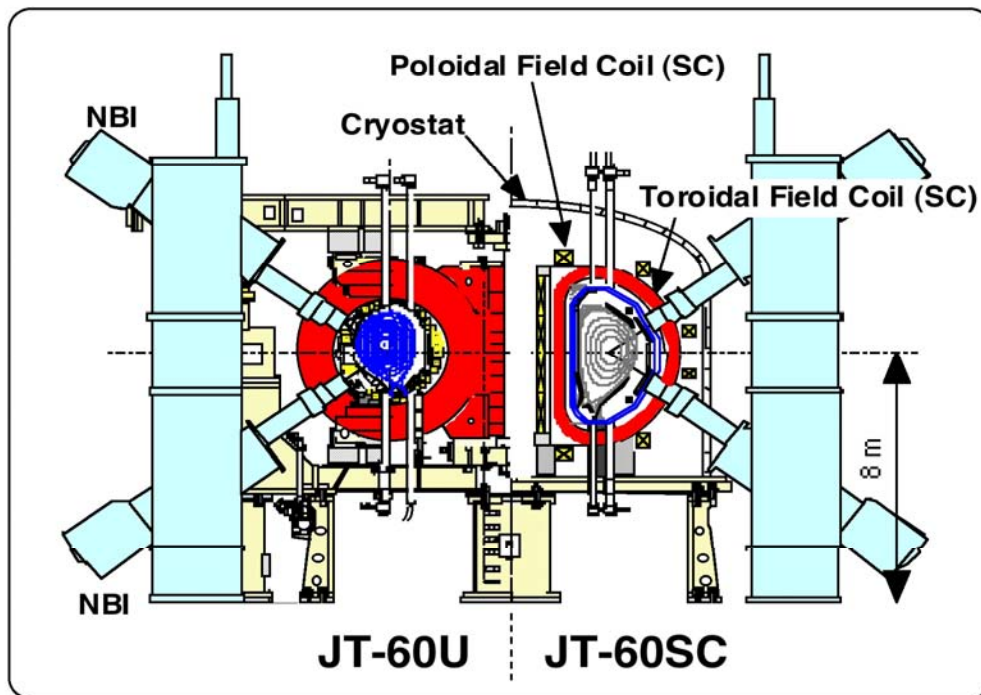

Designs for Components Test Facilities have been developed in the US and UK, based on the spherical tokamak

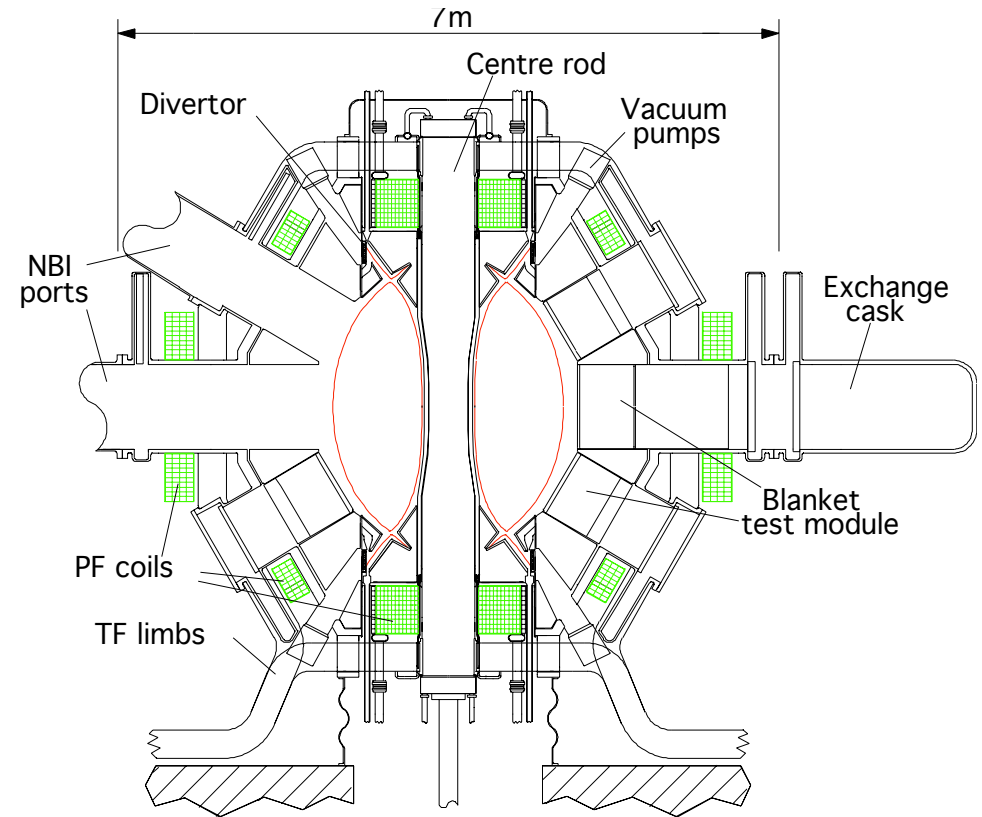
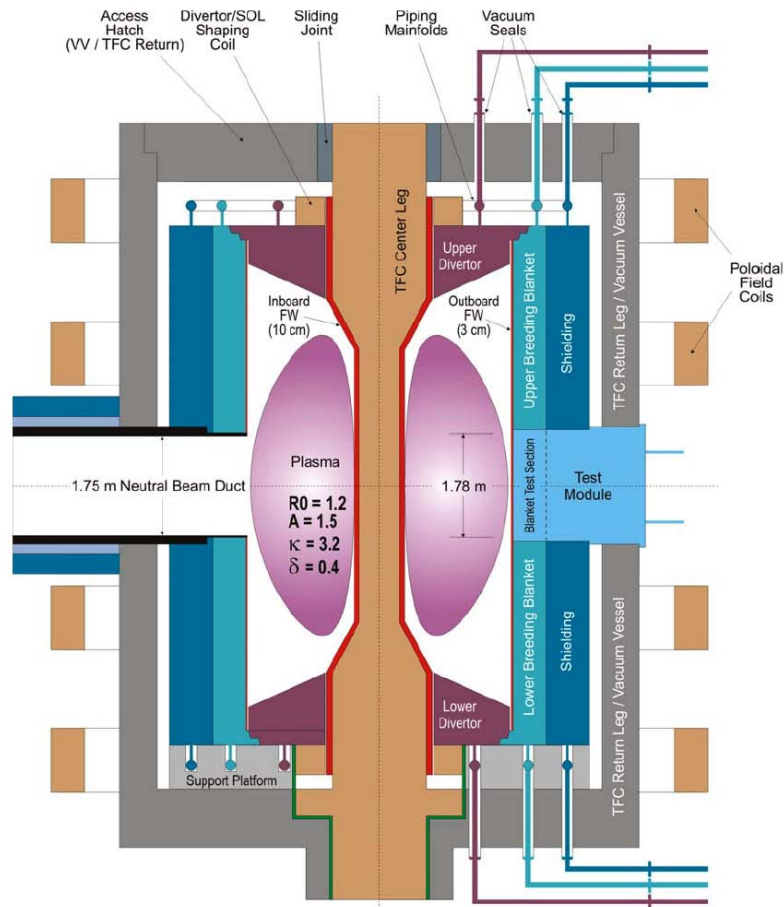

The Goals of a CTF

- The conditions necessary for testing were identified by an international committee [1]:
 - A fusion neutron wall loading in the range $1\text{-}2\text{MWm}^{-2}$
 - Steady state operation
 - A total neutron fluence of $\sim 6\text{MW-yrm}^{-2}$ within ~ 12 years
 - Total test area exceeding 10m^2
 - Magnetic field strength exceeding 2T
- We explore the possibility that a driven burning plasma spherical tokamak can meet these requirements



High- β Steady-State Advanced Tokamak Regimes for ITER and FIRE

- A study has been undertaken to develop high power density steady-state scenarios for FIRE and ITER that would lead to attractive power plants.
- A FIRE scenario has been developed that has power plant fusion power density of 5.5 MWm^{-3} , neutron wall loading of 2 MWm^{-2} . The scenario has 100% non-inductive current drive and would be capable of steady-state operation. FIRE with copper magnets could sustain this type of discharge for $\sim 35\tau_E$, $10 \tau_{\text{He}}$ and 4 current profile redistribution times (τ_{CR}) which is long enough to study the burning plasma physics and advanced tokamak evolution. (see slide 2)
- ITER scenarios are also being developed using NINB, ICFW and LH for current drive. Initial results with un-optimized current profiles show that steady-state ($\approx 100\%$ non-inductive) discharges can be attained for $\beta_N = 2.5$ and $\approx 50\%$ bootstrap current fraction. This work is ongoing with the goal of attaining steady-state scenarios with $\beta_N = 3.5$ and $> 60\%$ bootstrap current fraction. This extended performance capability would enhance the capability of ITER for extended nuclear testing. (see slide 3)

“Steady-State” High- β Advanced Tokamak Discharge on FIRE

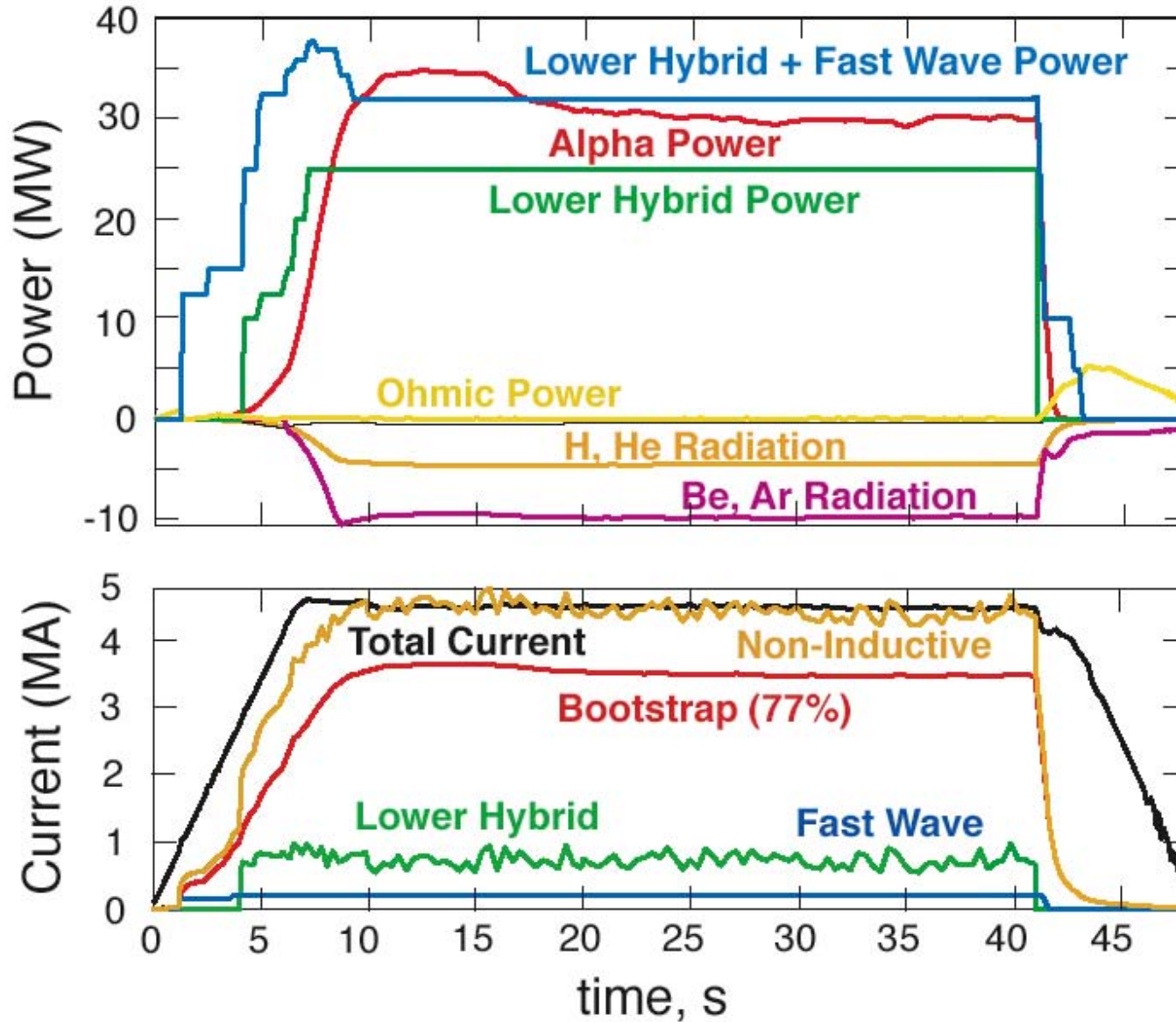

$P_f/V = 5.5 \text{ MWm}^{-3}$
 $\Gamma_n \approx 2 \text{ MWm}^{-2}$
 $B = 6.5 \text{ T}$
 $\beta_N = 4.1$
 $f_{bs} = 77\%$
 100% non-inductive
 $Q \approx 5$
 $H_{98} = 1.7$
 $n/n_{GW} = 0.85$
 $\tau_E = 0.7 \text{ s}$
 $\tau_{He} = 3.5 \text{ s}$
 $\tau_{cr} = 9 \text{ s}$



Fusion Technology

Table I. Advanced Tokamak Parameters

	ITER-AT	PPCS-C	FIRE-AT	ARIES-RS	ASSTR-2
R (m), a (m)	6.35, 1.85	7.5, 2.5	2.14, 0.595	5.52, 1.38	6, 1.5
$\kappa_x, \kappa_a, \kappa_{95}$	-, 1.85, 1.82	2.1, 1.9,	2.0, 1.85, 1.82	1.9, -, 1.70	-, -, 1.8
δ_x, δ_{95}	0.55, 0.40	0.7, 0.47,	0.7, 0.55	0.77, 0.5	-, 0.4
Div. Config., material	SN, C(W)	SN, W	DN, W	DN, W	SN, W
$(P_{loss})/R$ (MW/m)	15	~70	16	80	~100
$B_t(R_0)$ (T), I_p (MA)	5.1, 9	6, 20	6.5, 4.5	8, 11.3	11, 12
$q(0), q_{min}, q_{95}$	3.5, 2.2, 5.3		4, 2.7, 4.0	2.8, 2.49, 3.5	-, -, 4.8
$\beta_t(\%), \beta_N, \beta_p$	2.8, 3.1, 1.5	5, 4,	4, 4.1, 2.15	5, 4.8, 2.29	-, 3.7, -
$f_{bs}(\%)$	48	63	77	88	80
Current Drive Tech	NIBI, ECF	NBI	ICFW, LHF	ICFW, LHF	NINB
Non Inductive CD. %	100	100	100	100	100
$n(0)/\langle n \rangle_{vol}, T(0)/\langle T \rangle_{vol}$	1.3, 2.4	1.5, 2.5	1.5, 3.0	1.5, 1.7	1.5, -
$n/n_G, \langle n \rangle_{vol} (10^{20} m^{-3})$	0.8	, 1.2	0.85, 2.4	1.7, 2.1	1.2, 2.1
$T_i(0), T_e(0)$	27, 25	25	14, 16	27, 28	~35
Z_{eff}	2.1	2.2	2.3	1.7	1.6
H98(y,2)	1.6	1.3	1.7	1.4	
τ_E (s)	2.7		0.7	1.5	
Burn Duration/ τ_{cr} , s	10, 3000	Steady-state	4, 32	Steady-state	Steady-state
$Q = P_{fusion}/(P_{aux} + P_{OH})$	6	30	4.8	25	58
Fusion Power (MW)	360	3400	140	2160	3530
P_{fus}/Vol (MWm ⁻³)	0.45	1.9	5.5	6.2	7.3
Γ neutron (MWm ⁻²)	0.5	2.2	1.7	4	4.7



Fusion Technology

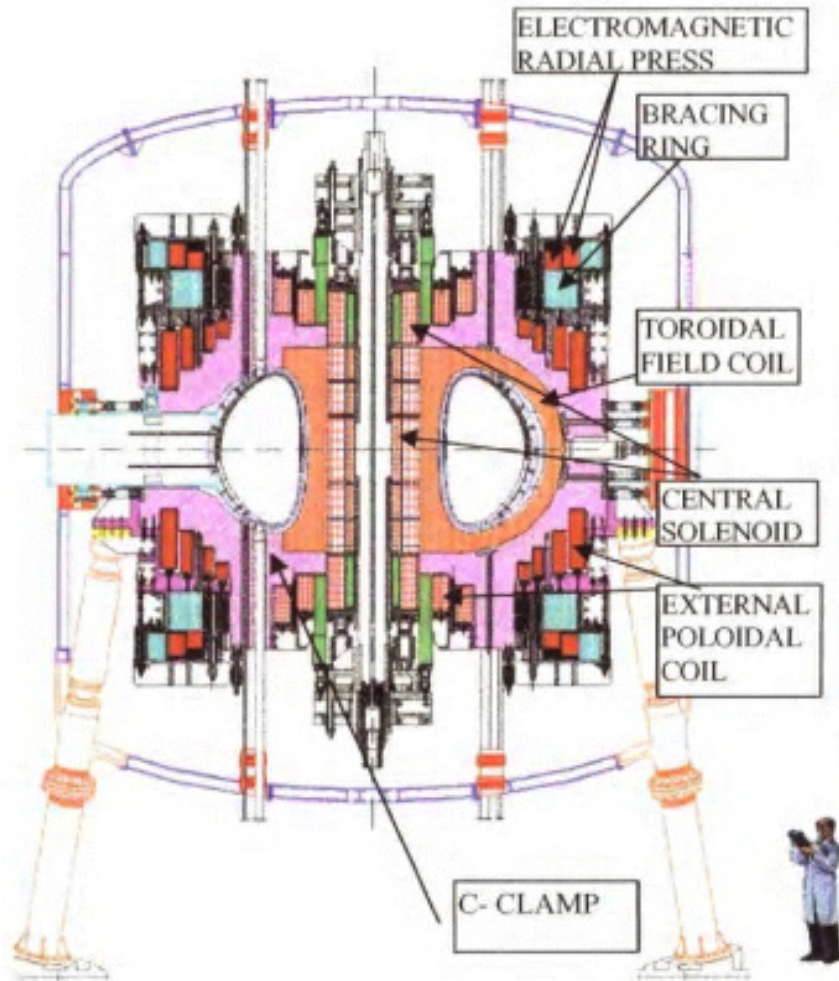

Fig. 2

TABLE I: EXAMPLE OF PLASMA PARAMETERS WHEN IGNITION IS REACHED (JETTO CODE)

Toroidal Plasma Current I_p	11 MA
Toroidal Field B_T	13 T
Central Electron Temperature T_{e0}	11.5 keV
Central Ion Temperature T_{i0}	10.5 keV
Central Electron Density n_{e0}	$9.5 \times 10^{20} \text{ m}^{-3}$
Central Plasma Pressure p_0	3.3 MPa
Alpha Density Parameter n_{α}^*	$1.2 \times 10^{18} \text{ m}^{-3}$
Average Alpha Density $\langle n_{\alpha} \rangle$	$1.1 \times 10^{17} \text{ m}^{-3}$
Fusion Alpha Power P_{α}	19.2 MW
Plasma Stored Energy W	11.9 MJ
Ohmic Power P_{OH}	11.2 MW
ICRF Power P_{ICRH}	0
Bremsstrahlung Power Loss P_{brem}	3.9 MW
Poloidal Beta $\langle \beta_p \rangle$	0.20
Toroidal Beta $\langle \beta_T \rangle$	1.2 %
Central "safety factor" q_0	$\cong 1.1$
Edge safety factor $q_{\psi} = q_{\psi}(a)$	3.5
Bootstrap Current I_{bs}	0.86 MA
Poloidal Plasma Current	$\cong 8.4 \text{ MA}$
Energy Replacement Time τ_E	0.62 sec
Alpha Slowing Down Time $\tau_{\alpha sd}$	0.05 sec
Average Effective Charge $\langle Z_{eff} \rangle$	1.2

$$n_{\alpha}^* \cong n_D n_T \langle \sigma v \rangle \tau_{\alpha sd}$$

$$\tau_{\alpha sd} \cong 0.012 T_{e0}^{3/2} (\text{keV}) / n_{e0} (10^{20} \text{ m}^{-3})$$



- **Heating and Current Drive**



Fusion gyrotron performance. Main results since 2000.

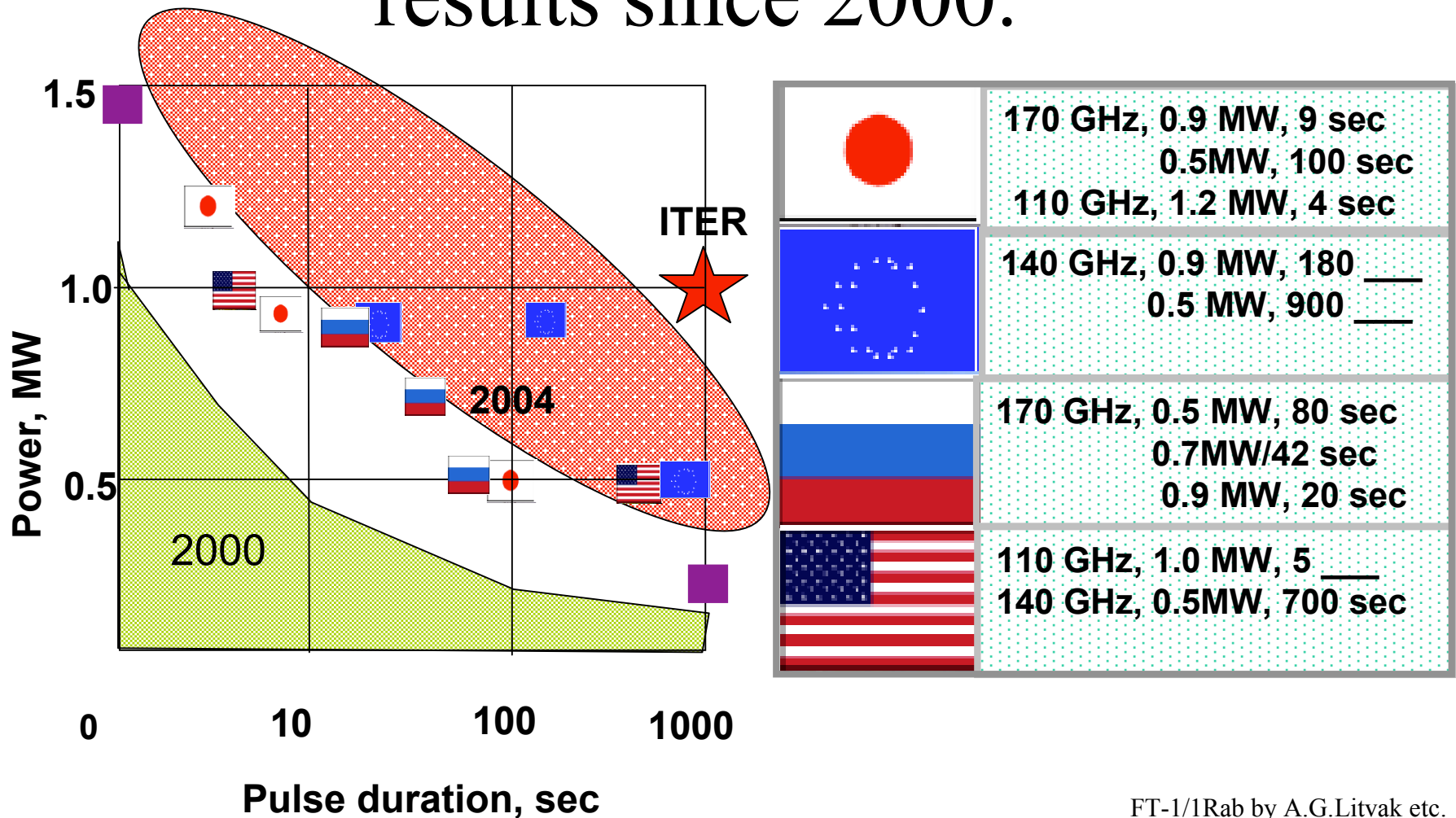



Development of Steady-State 2-MW 170-GHz Gyrotrons for ITER

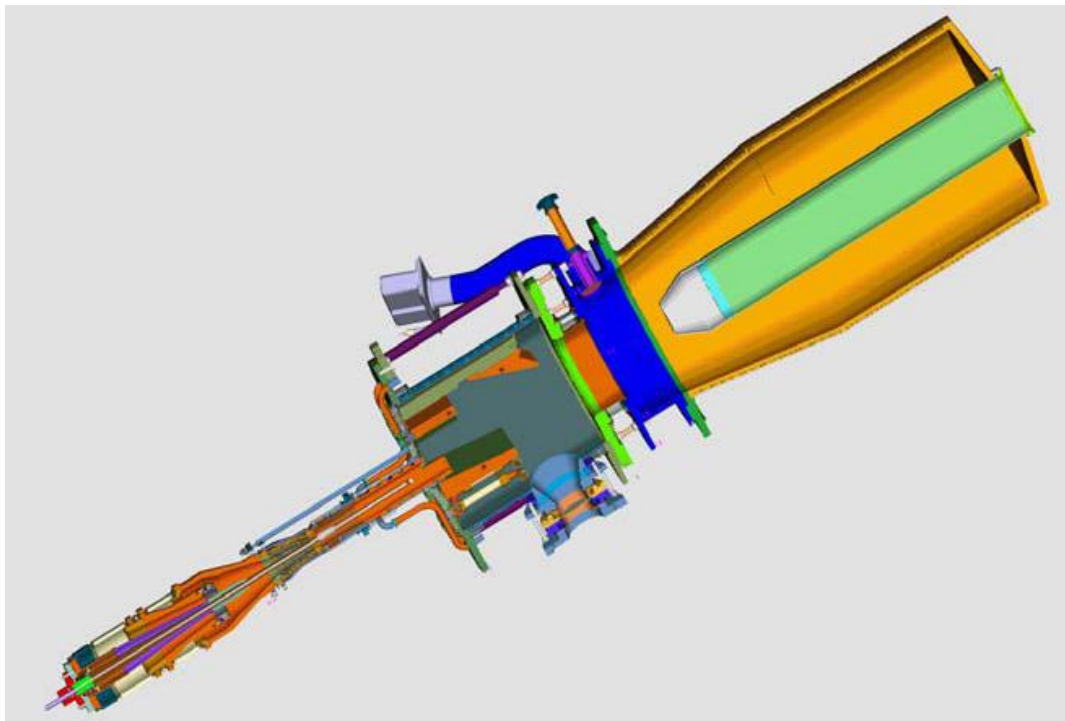

Fig. 1. Cut of the integrated 170 GHz, 2 MW, CW coaxial cavity

Based on these results the development of a coaxial cavity gyrotron with an RF output power of 2 MW, CW at 170 GHz as could be used for ITER is in progress in cooperation between European Associations (CRPP Lausanne, FZK Karlsruhe and HUT Helsinki) together with European tube industry TED. The conceptual design of such a tube compatible with CW operation has been completed (Fig.1) and the manufacturing process of a first prototype has been launched.

Trend In ICRF Launcher Design: Decrease sensitivity to target plasma characteristics

- Design goal:
 - 20 MW through single port, 40-55 MHz
 - produce launcher with input impedance insensitive to changes in loading
 - minimize electric fields in antenna structure for a given level of current on radiating elements
- Note: recent advances in 3-D electromagnetic modeling capabilities are proving very useful! (Discussed later...)

ITER ICRF Launcher (Baseline Design)

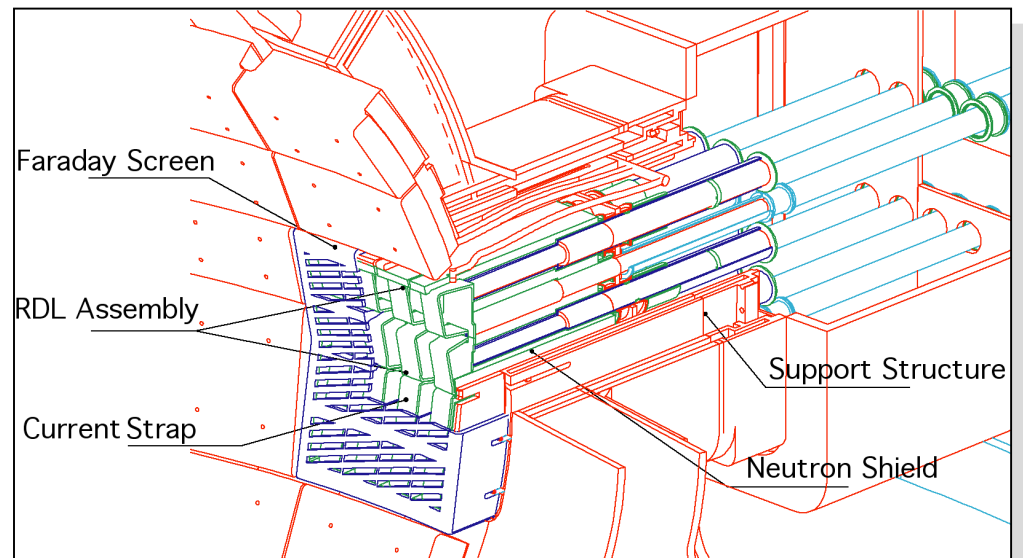

High Power Prototype (HPP)

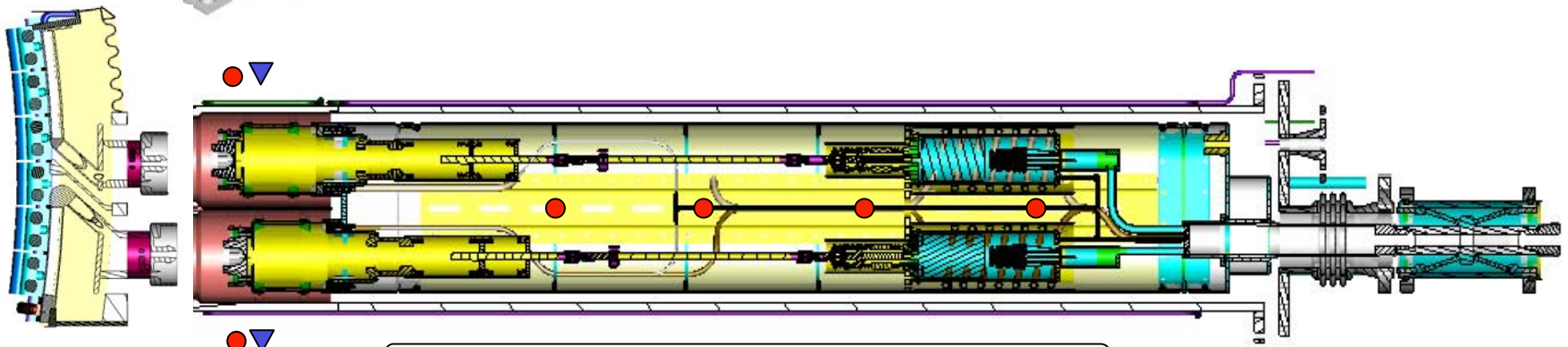
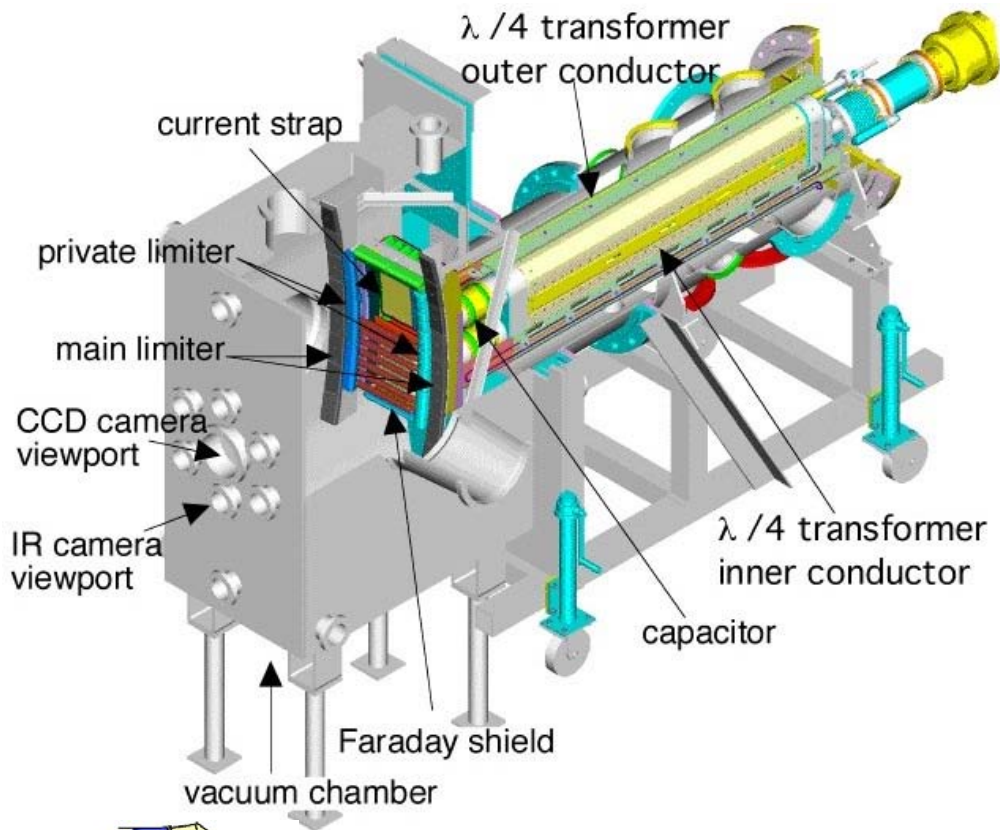



Neutral Beam: R&D on ion sources and accelerators Negative-ion based NB system



Accelerator structure in LHD N-NBI

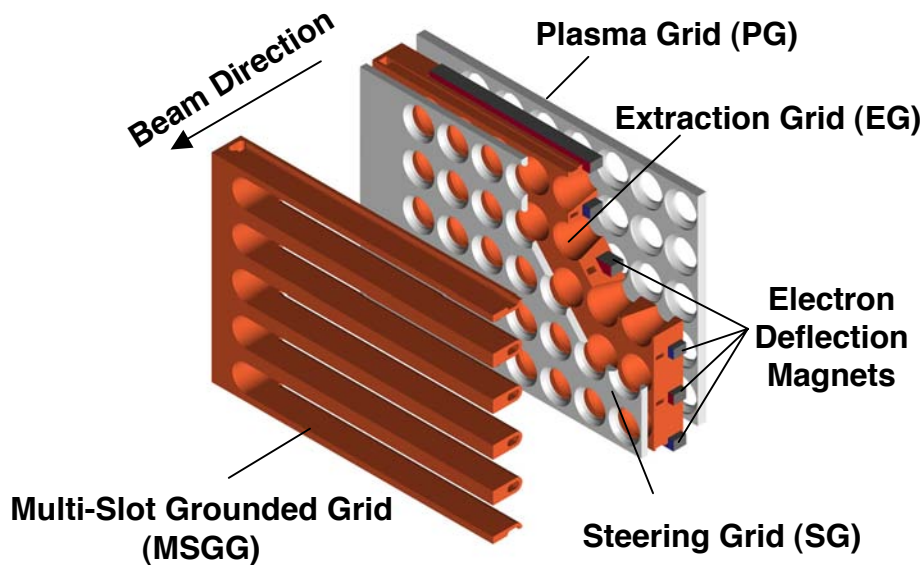

Progress of NB power in LHD

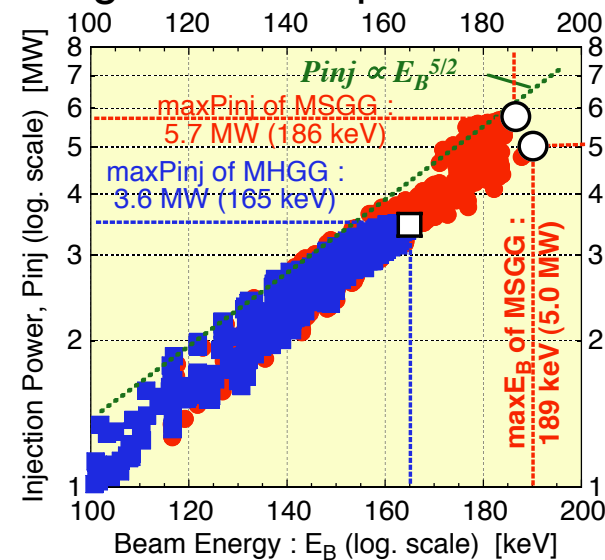

- In LHD N-NB system, heat load on the grounded grid was reduced to a half by applying a multi-slot grounded grid.
 - 5.7 MW at 186 keV (H^0) for 1.6 s.
- In JT-60U N-NB system, a long pulse operation is in progress:
 - 5.8 MW at 400 keV (D^0) for 0.86 s.
 - 1.6 MW at 366 keV (D^0) for 17 s.



Fusion Technology

- **Engineering Design and Technologies**



The European Development of Helium-cooled Divertors Principle conceptual designs of divertor target cooling (1 W armour, 2 W thimble, 3 flow or jet flow promoter, 4 steel structure)

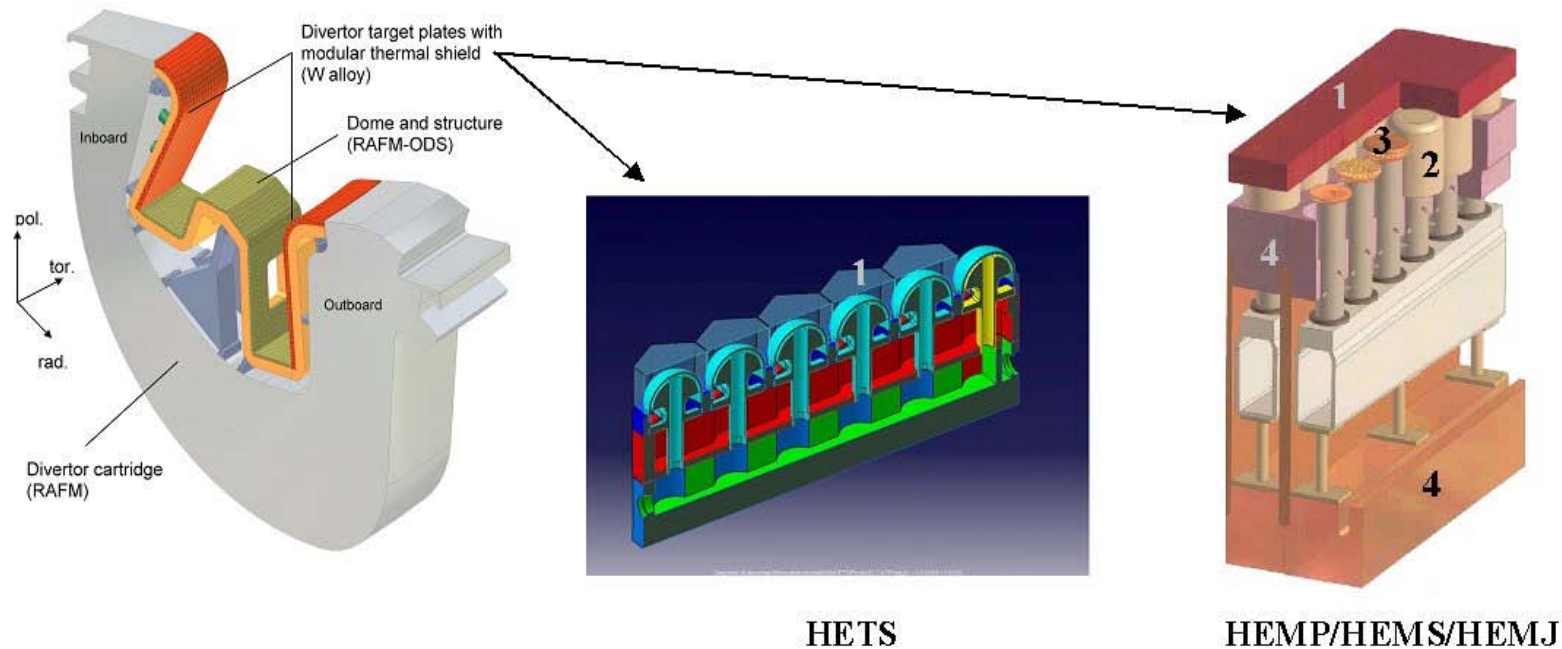

Experimental Studies on Tungsten-armor Impact on Nuclear Responses of Solid Breeding Blanket

S. Sato, et. al., JAERI, FT/P1-13

Distributions of the local TPR from ${}^6\text{Li}$.

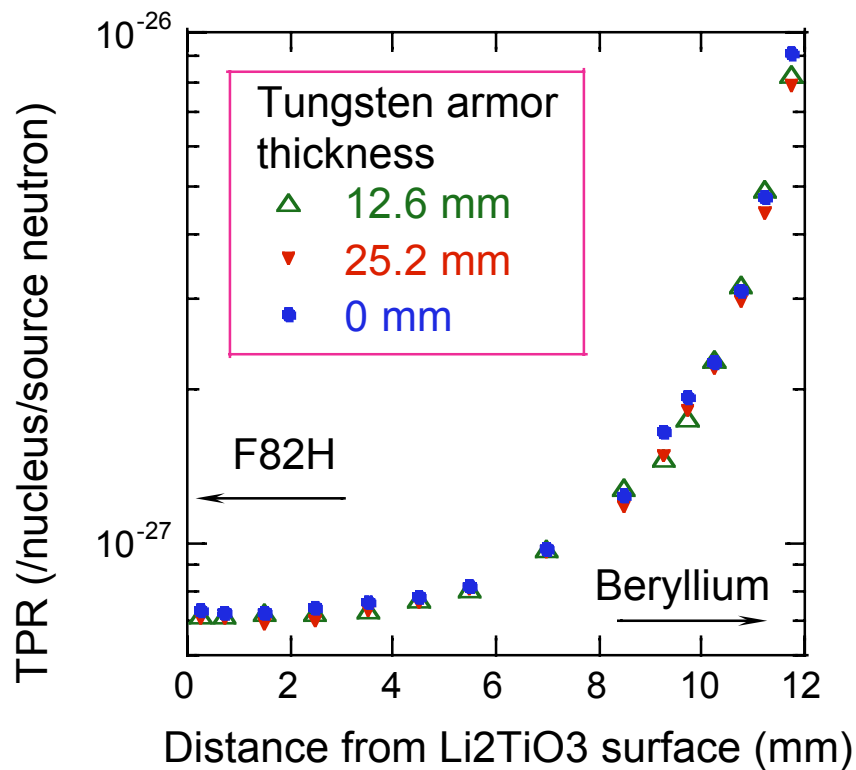

Ratios of tritium production as a function of tungsten thickness.

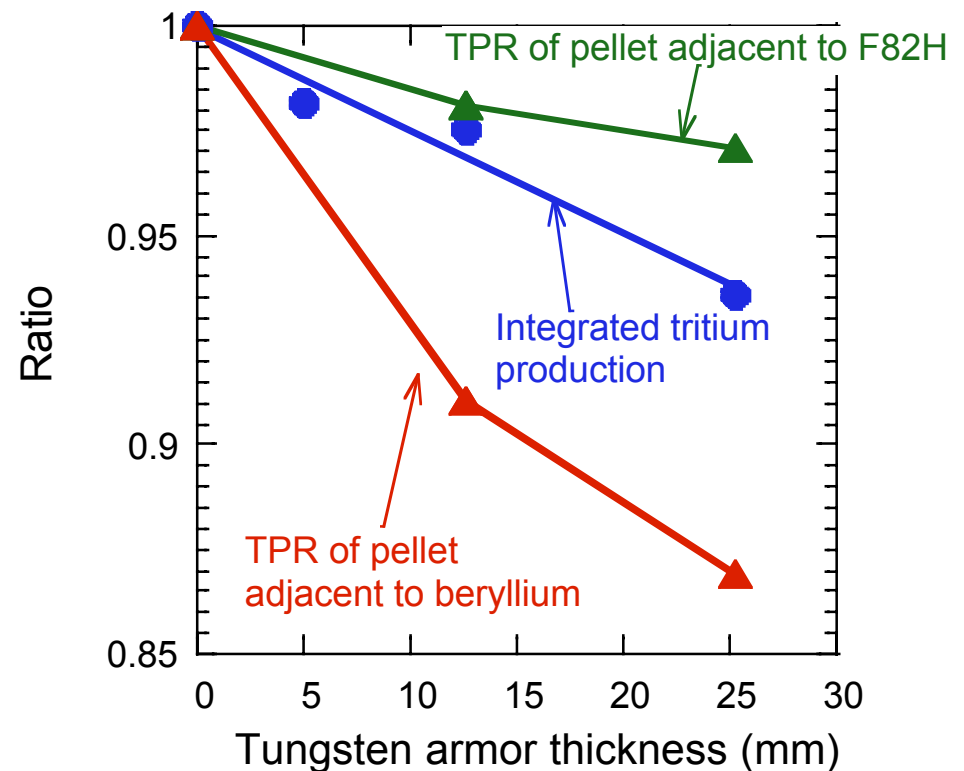

By installing 5, 12.6, 25.2 mm thick tungsten, integrated tritium productions are reduced by 2, 3, 6 % relative to the case without armor, respectively.



Fusion Technology

- **Plasma Control**

Integrated Plasma Control for High Performance Tokamaks

New NTM Control Algorithm on DIII-D Maintains Island/ECCD Alignment Using Realtime q-Profile Reconstruction

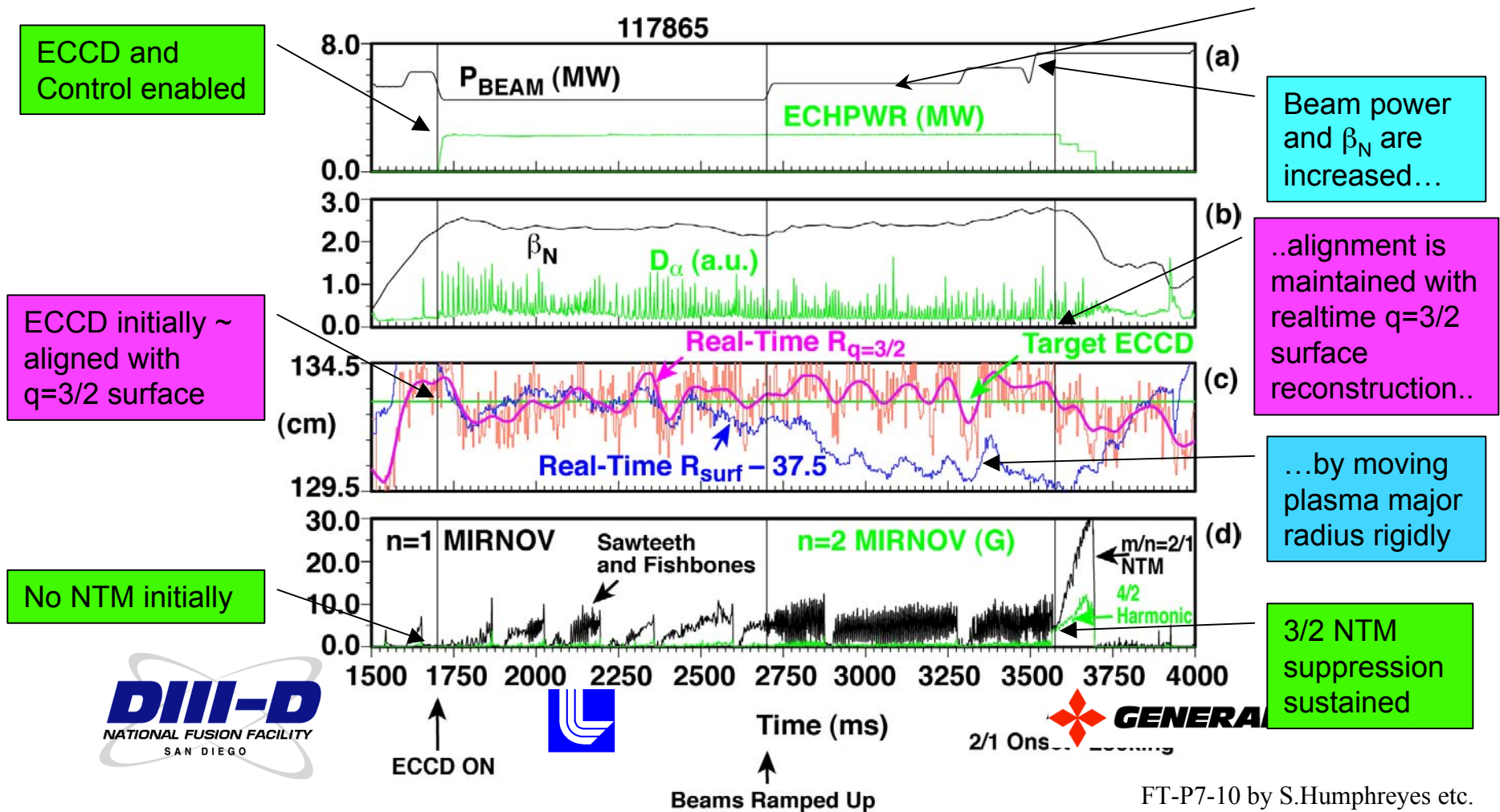



Fusion Technology

● Materials and Testing Facilities

Progress of Radiation Damage Evaluation for DEMO and ITER blankets

Target and accomplished damage level in "displacement per atom (dpa)"

	2002		2004		Target level	
	ITER TBM	DEMO	ITER TBM	DEMO	ITER TBM	DEMO
Short Term Mechanical Properties						
Tensile					>3dpa	>150dpa
Fracture Toughness					>3dpa	>150dpa
Fatigue					>3dpa	>150dpa
Creep					>3dpa	>150dpa
Compatibility						
Cracking (EAC)					>3dpa	>150dpa
Corrosion					>3dpa	>150dpa
Materials Engineering						
Joining					>3dpa	>150dpa
Condition Change					>3dpa	>150dpa
Plasticity/Ductility					>3dpa	>150dpa
Codes						
Design						
Maintenance						

IFMIF
High Damage Levels

A large progress in materials property evaluation for ITER TBM application has been accomplished

Fission reactor irradiation produces too small level of He atoms. For evaluation with high enough accuracy, facility like IFMIF is needed.



Fusion Technology

IFMIF Layout

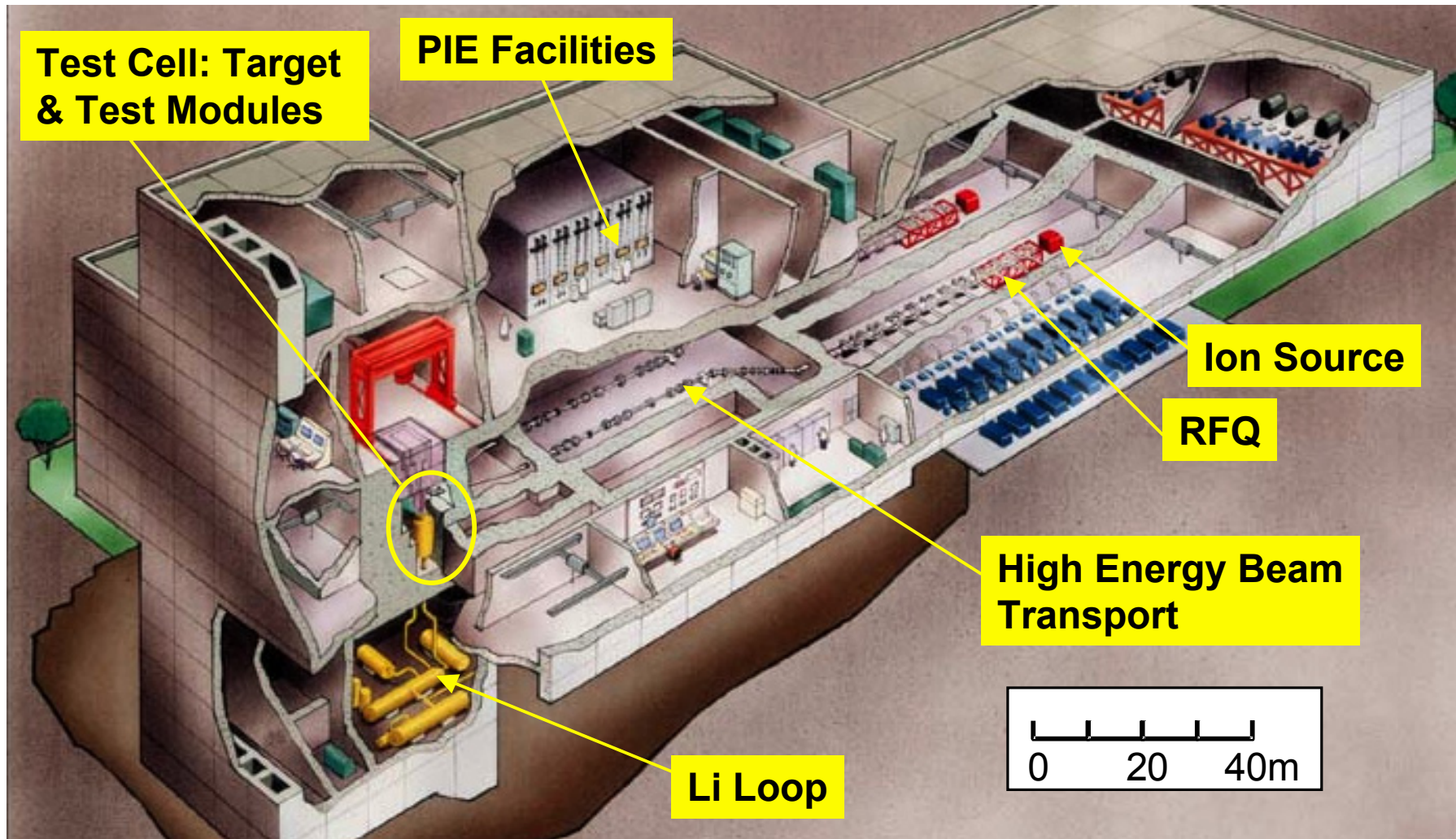

The International Fusion Materials Irradiation Facility (IFMIF)



Small specimen test techniques (SSTT)

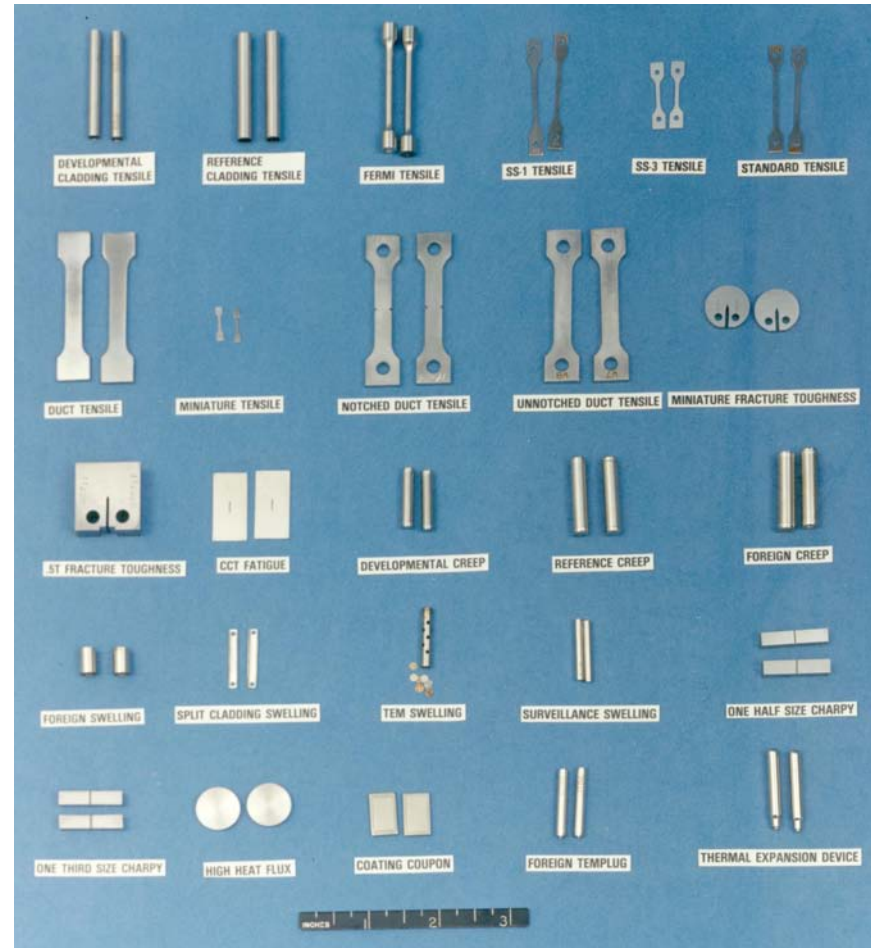

Example of SSTT specimens for IFMIF



Proposed Power planes(concept)

<u>Name</u>	<u>Country</u>	<u>Institution</u>	<u>Type</u>	<u>Reference</u>
FFHR2m	Japan	NIFS	LHD-type	FT-3/6
VECTOR	Japan	JEARI	L-A Tokamak	FT-P-7/35
CFER-ST.	China	SWIP	ST Tokamak	FT-P-7/1



LHD-type D-T Reactor FFHR



Many advantages :

- current-less
- Steady state
- no current drive power
- Intrinsic divertor

LHD operation: 1998



$$\gamma = \tan \theta$$

Selection of lower $\gamma = \left(\frac{m a_c}{l R} \right)$

- To reduce mag. foop force
- To expand blanket space

- 1993 FFHR-1 ($l=3, m=18$)
 $R=20, Bt=12T, \beta=0.7\%$
- 1995 FFHR-2 ($l=2, m=10$)
 $R=10, Bt=10T, \beta=1.8\%$

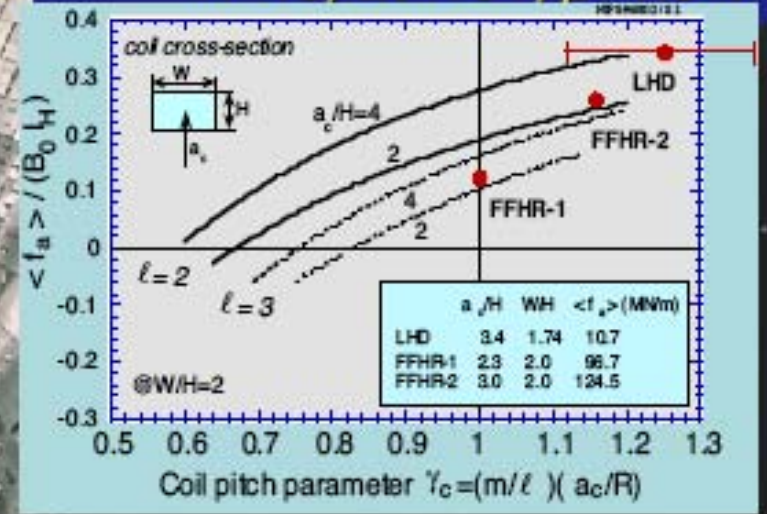
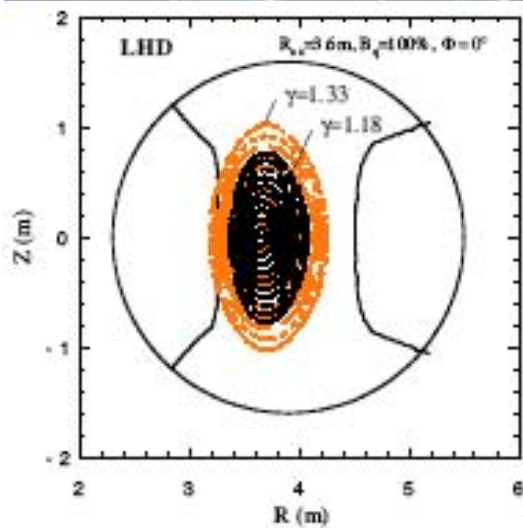



Presentation Outline

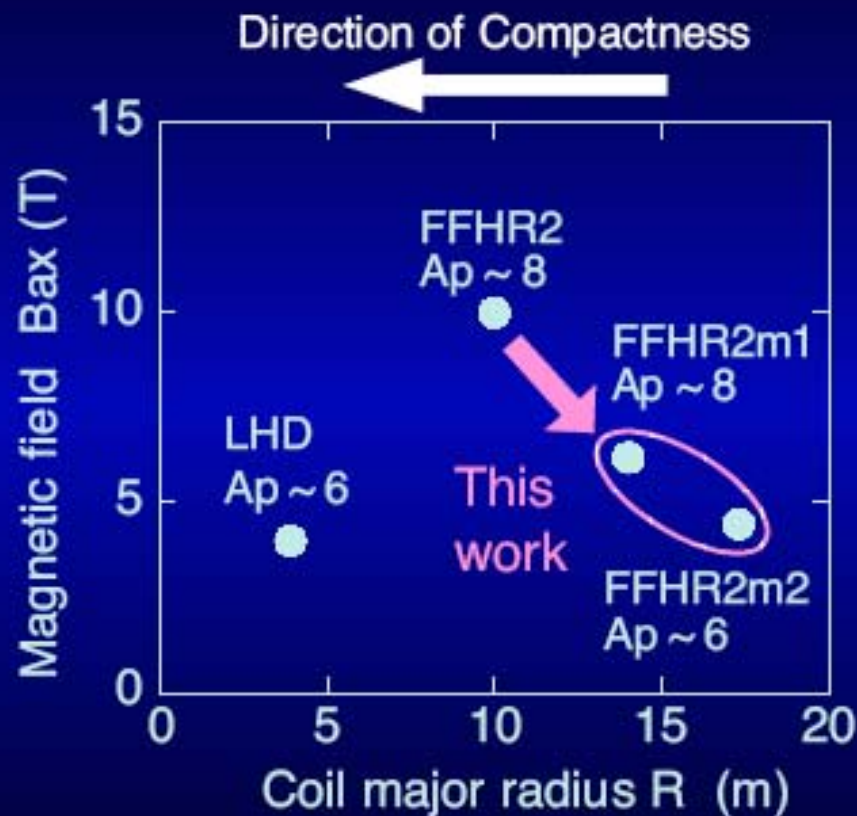

1. Introduction of FFHR

2. New design approach

- The size is increased
- Why ?

3. Conclusions

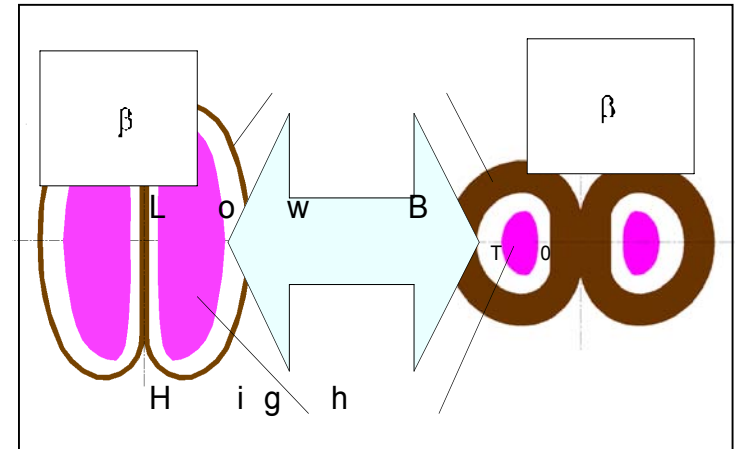
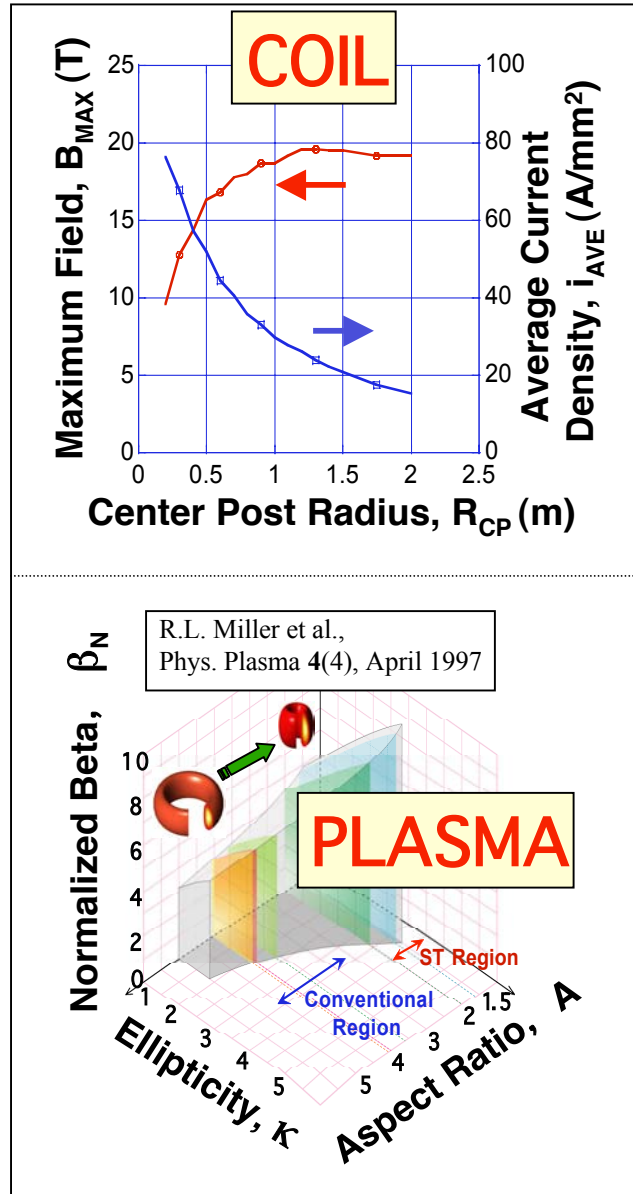
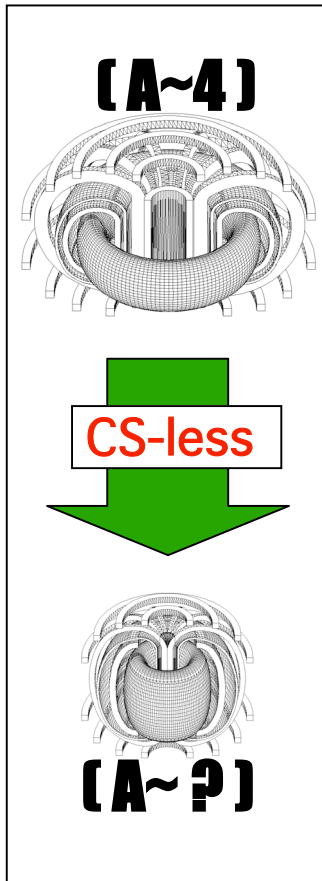

Weight Power Density

VECTOR

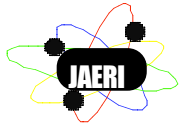

This is the VECTOR.

(9)

JAERI

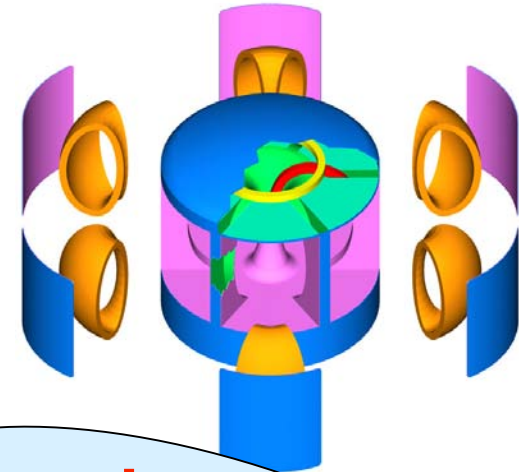
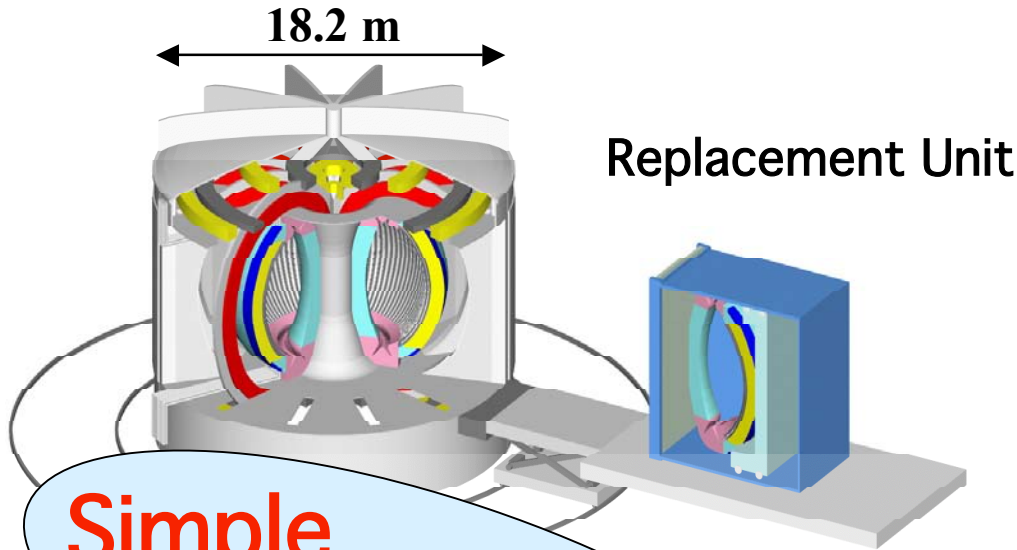

**Simple
Maintenance
Scheme**

**Simple
Vacuum
Boundary**

Plasma Major Radius : $R_p = 3.2$ m
 Plasma Minor Radius : $a_p = 1.4$ m
 Plasma Ellipticity : $\kappa = 2.35$
 Plasma Current : $I_p = 14$ MA
 Normalized Beta : $\beta_N = 5.7$

Fusion Power : $P_F = 2.5$ GW
 Neutron Wall Load : $P_n = 5$ MW/m²
 Field on axis : $B_0 = 5$ T
 Reactor Weight : $W = 8800$ Ton
 Weight Power Dens. : $p = 280$ kW/ton



Summary

- The world needs new major energy sources which should be safe, sustainable and environmentally responsible;
- Fusion energy is the most attractive options
- Time is to move to Power Plant Studies oriented to DEMO
- **Before the DEMO, ITER is the necessary next step;**
- Before the ITER to continue the wider investigation both physics and technologies on exist and new device are necessary
- In parallel, concept development of stellarators, spherical tokamaks,.....also are necessary;



20th IAEA FEC



France(Cadarache)

??



Japan (Rokkasho)

The “fast track” of fusion development should start up as early as possible. So it is hoped that the deadlock for ITER site can be overcome as soon as possible



Canada(Clarington)



Spain(Vandellòs)



20th IAEA FEC

Thanks